

Mechanical Rebar Splice Solutions





About BARUS® LLC	5
Why a Mechanical Splice?	6
BARUS® Product range	8
SimGrip™ Upset Parallel System	16
SimGrip™ System Equipments	20
SimGrip™ Standart	24
SimGrip™ LT	26
SimGrip™ PS	28
SimGrip™ Crossing	30
SimGrip™ TS	32
Anchor - Nut™	36
Structural Solutions	39
TTEX System	40
Benefits of Swage System Couplers	42
Griplock System	44
Griplock System Equipments	46
Griplock SL	48
Griplock FM	50
Griplock PS	52
Griplock Crossing	54
Other Griplock Types and Typical Connections	56
Accessories	60



ABOUT US

BARUS® LLC, incorporated in California, USA, is a global design, manufacturing and service company of engineered splice solutions for the heavy construction industry. BARUS mechanical reinforcing bar couplers, anchorage, structural products, pre-cast connectors and similar value-added engineered splice systems offer a variety of solutions to meet the challenges of heavy construction.

Powered by manufacturing and engineering capabilities, BARUS is committed to exceptional customer satisfaction, sustainable product initiatives and service quality at every job site. Because BARUS values our customers, we employ a dedicated staff of administrators, engineers, and technicians to ensure that we provide the best customer service possible.



DESIGN

Our Research and Development team is comprised of skilled Mechanical, Civil and Industrial Engineers. These dedicated professionals specialize in rebar splice solutions for challenging construction projects. In addition to the products in our catalogs, we can custom design special mechanical connectors and a variety of other engineered steel products to fit the needs of each project. For large-scale projects, we also offer solutions for your rebar splice design problems.

PRODUCTION

BARUS production follows the guidelines established by our Quality Assurance Program and we are certified by an ISO 9001 Quality Management Systems accredited agency. Our certification was granted because quality and accountability are two major pillars in our production process. All of our materials, documents and processes are carefully filed for traceability and a tracing code is printed on each product we produce.

BARUS also manufactures rebar splicing solutions locally to avoid long lead times, transportation and customs issues, and the expenses of manufacturing abroad.



SERVICE

BARUS assists our customers throughout the entire production process: from concept and design to the installation at the job site. Our aim is to provide the most applicable and economical design solutions for mechanical couplers.

Along with our design and manufacturing abilities, we also offer an extensive array of related services, such as rebar upsetting and threading, at your job site. In addition, our equipment and technicians are available for the duration of the project so that you don't need to purchase any equipment or hire extra technicians.



BENEFITS of MECHANICAL SPLICING

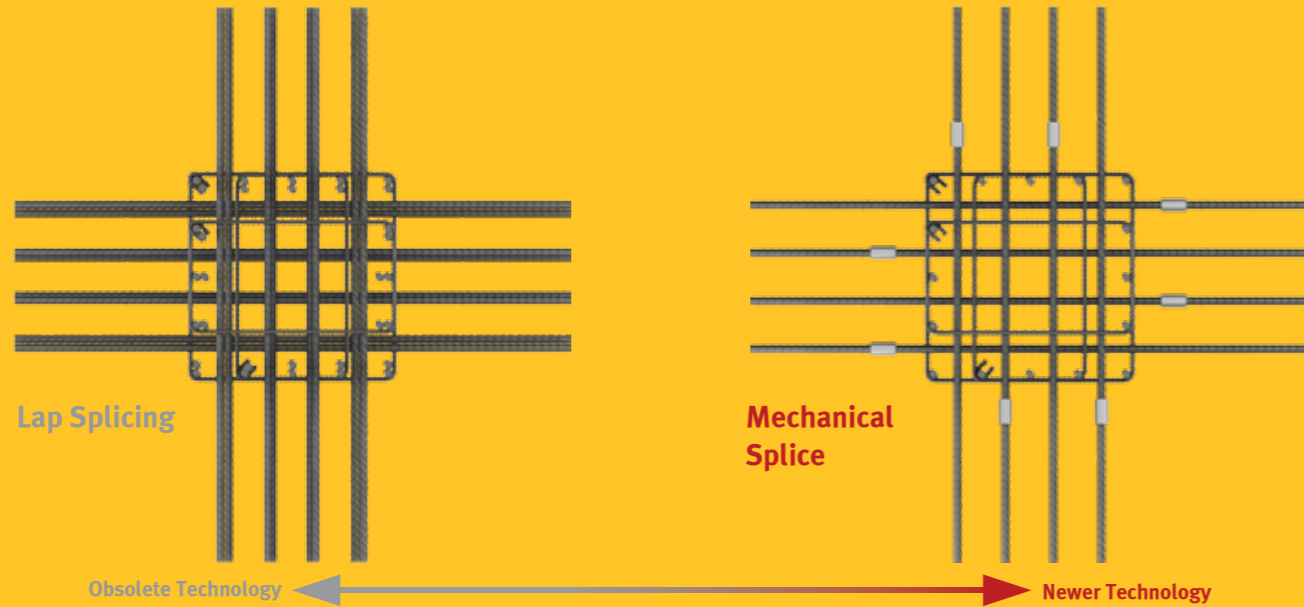

WHY A MECHANICAL SPLICE?

Due to the growing technical challenges faced in today's construction industry, traditional methods for connecting rebar, such as lapping or welding, are no longer the best methods to connect rebar. More and more construction codes are specifying a mechanical coupler because it provides better structural integrity while minimizing costs. Here you can find some benefits of using BARUS mechanical couplers listed below:

- **More reliable and more structural integrity than lap splices because they no longer rely on the concrete for load transfer**
- **Reduces the amount of rebar, which reduces the labor and crane time – improving the construction schedule**
- **Lower risk of rock and air pockets by reducing rebar congestion**
- **No lapping length necessary – reduces inventory which lowers cost**
- **Efficient and easy design options result in smaller and stronger columns with the maximum amount of useful area**
- **Better splice inspection – lowers quality control costs**
- **Avoids drilling and/or cutting forms, especially in crane, elevator openings, and stairwells**
- **Allows for same line splicing – no staggered splices**
- **Installs easily and quickly**
- **Minimizes rebar waste**

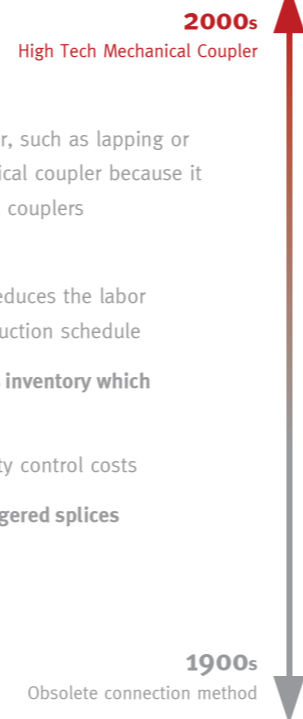

SIMPLICITY

allows for the design of fast, easy, economic, and ultimately, enjoyable construction projects.

More and more engineers are specifying mechanical rebar connections over lap splices. They have found that mechanical connections provide reliability and consistency that can not be found in lap splicing.

Stress - Strain Diagram

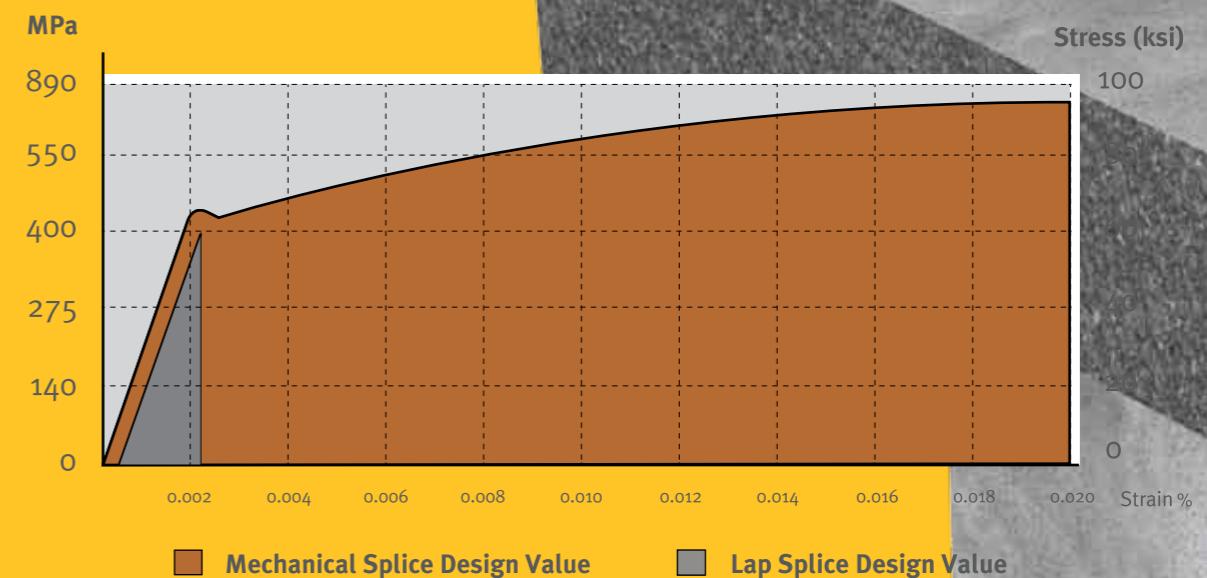

OUR PRODUCTS

Due to the growing technical challenges faced in today's construction industry, traditional methods for connecting rebar, such as lapping or welding, is no longer the best method to connect rebar. Mechanical coupler is an effective method of connecting rebar which provides better structural integrity while minimizing costs.

The BARUS range of reinforcing bar couplers is the most comprehensive available and includes SimGrip parallel threaded, GripLock swage and Jawws shear bolt mechanical couplers.

All BARUS products require use of BARUS equipments and accessories to ensure that they will consistently perform and produce related test requirements.



simGRIP™ system

Upset Parallel Thread System Mechanical Coupler

BARUS SimGrip™ System is a mechanical coupler comprised of a steel sleeve which is internally threaded with a single right hand thread. The ends of bars are upset and threaded. The SimGrip™ family of upset parallel thread mechanical couplers requires a BARUS cold upset press and a tangential rebar threading machine.



Anchor - Nut™

The parallel threaded Anchor-Nut™ provides an alternative method of creating a simpler and more effective rebar end anchorage than the traditional hooked rebar within the concrete..

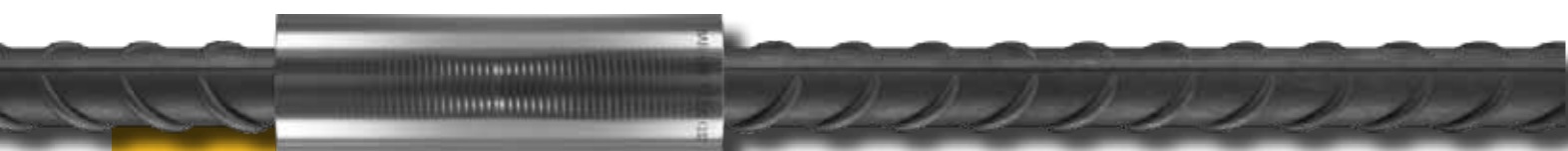

TTEX™ system

Tapered Thread Mechanical Coupler for Reinforcing Bars

BARUS TTEX™ System is a taper threaded mechanical coupler comprised of a steel sleeve which is internally threaded with a single right hand thread. The ends of bars are taper threaded.

TTEX™ family of tapered thread mechanical couplers requires a BARUS taper threading machine.



JAWWS™ system

Shear Screw Mechanical Coupler

Jawws™ Shear Screw Mechanical Couplers are comprised of a high quality steel body which is installed on a reinforcing bar with TC Bolts. Because the TC Bolts are screwed into the coupler, the studs in the coupler provide a mechanical interlock between the reinforcing bar and the coupler's inner wall. This is an improved interlock mechanism by creating a stronger interlock in a shower sleeve body. Jawws™ Shear Screw Mechanical Couplers can be installed using an impact wrench provided by BARUS.

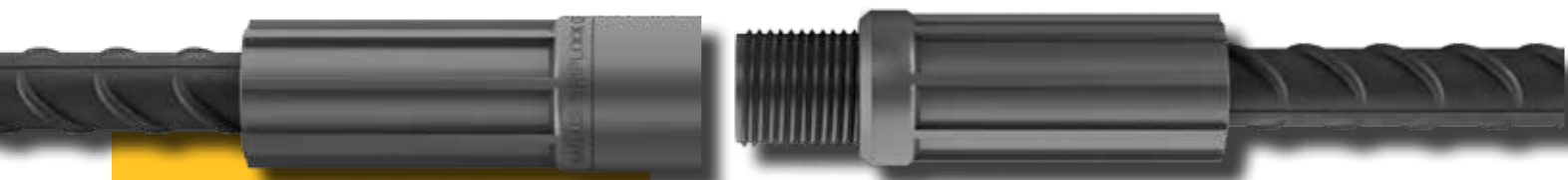

griplock™ system

Cold Swage System Mechanical Coupler

The Griplock™ System coupler is swaged onto the reinforcing bar's ribs to produce a mechanical interlock. Rebars are swaged onto the coupler. Griplock™ Cold Swage System Mechanical Couplers are a fast, economic and easy way to splice deformed reinforcing bars. The Griplock™ family of cold swage mechanical couplers requires a BARUS cold swage, bench and/or portable press.



griplock™ sl

GripLock™ SL is a sleeve-type coupler that slips over the ends of deformed reinforcing bars and swaged with a BARUS bench and/or portable press to produce a mechanical interlock between the deformed rebar profile and the sleeve coupler.

TYPICAL APPLICATIONS

- Slab to wall connection,
- **Precast beam to wall connection,**
- Column construction,
- **New construction, repair and retrofit,**
- Precast element-to-precast element connection,
- **Access openings,**
- Rebar cage prefabrication,
- **Rebar anchorage and termination.**

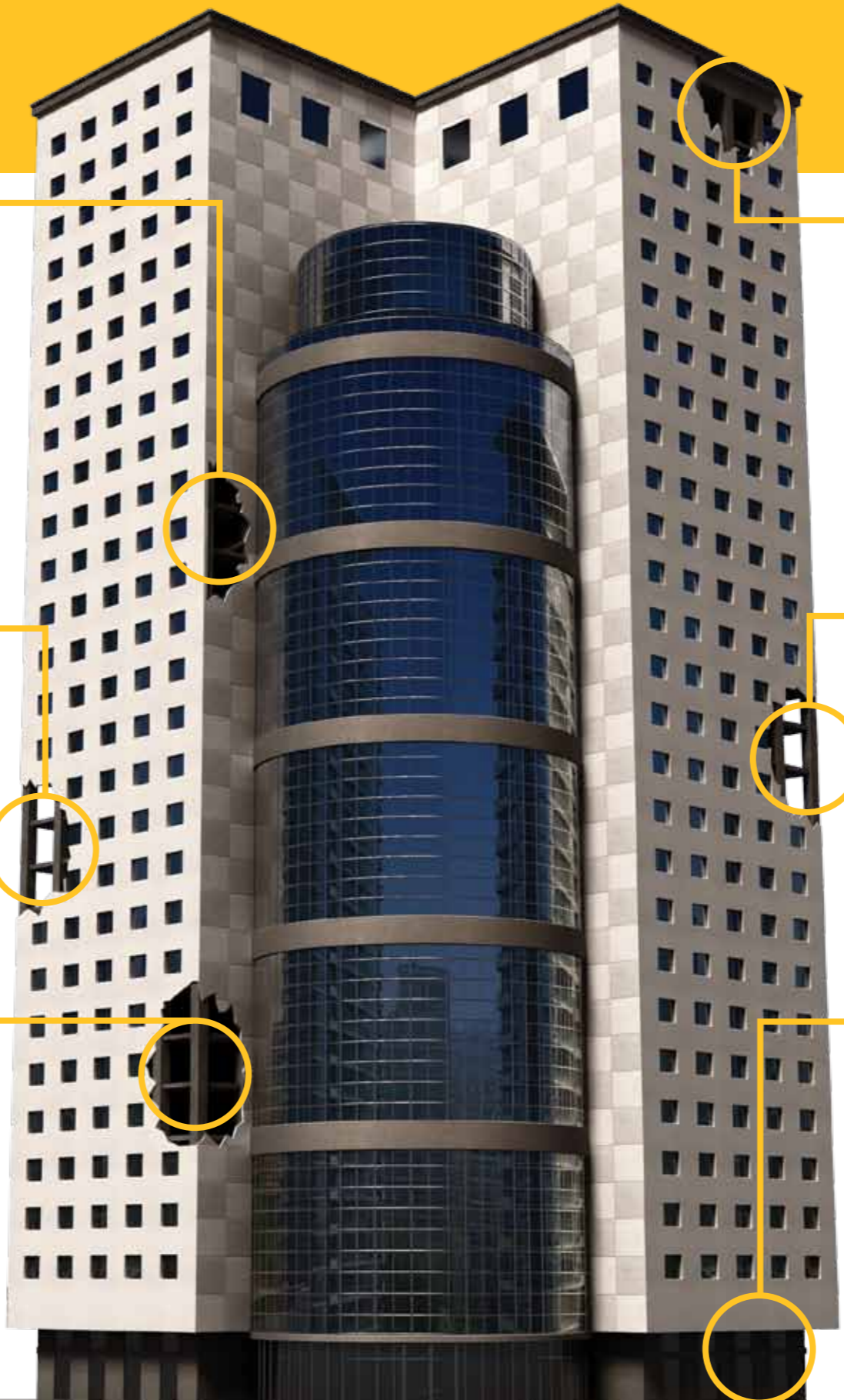

Stairwell Application with Formwork Adapter



BARUS formwork adapters and couplers are ideal for segmental concrete pours by eliminating both the need to bend protruding dowels and the need to drill through expensive formwork.

Concrete to Steel Connection Application with SimGrip™ WDC



BARUS SimGrip™ WDC couplers are designed to be arc welded to structural steel plates and shapes.

Slab to Wall Connection Application with Anchor Nut™ and SimGrip™ LT



BARUS Anchor Nut™ and SimGrip™ LT provide an effective total solution for connecting and anchoring rebar in concrete.

Rebar Anchorage / Termination Application with Anchor Nut™



BARUS Anchor Nut™ replaces a traditional hooked rebar and creates a more effective anchor.

Column Application with SimGrip™ LT

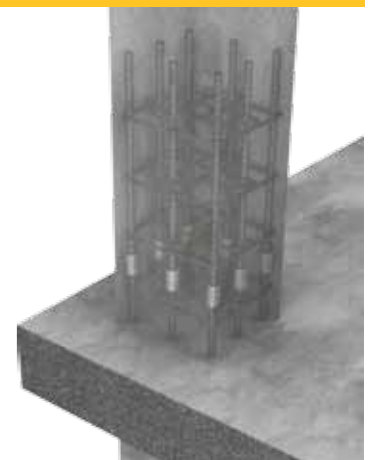

BARUS SimGrip™ LT produces a mechanical bar to bar connection that requires no special tools.

Foundation Application with Anchor Nut™



BARUS Anchor Nut™ replaces a traditional hooked rebar in foundations, pile caps and column footings to help simplify rebar placement and reduce rebar congestion.

SUSTAINABLE QUALITY ASSURANCE SYSTEM

BARUS Quality Control and Quality Assurance Systems provide sustainable quality for engineering, products and services.

Under the BARUS Quality Assurance Program, codes are stamped on all of our mechanical couplers. These codes allow the couplers to be traced back to the original lot of steel and the mill which produced it. Certified Material Test Reports (CMTR) are archived for future use as required.

BARUS couplers provides Full-Tension splice, bar break under tensile tests.

BARUS mechanical couplers are designed to exceed 125% of the specified yield strength in the US when used with Grade 60 rebars.

Bar Break performance for all standard rebars (Q12 - Q58)

BARUS Mechanical Couplers are designed to comply with:

ACI 349, ASME III DIV2 (ACI 359), ACI 318, Eurocode 2, TS 500, DBYBHY, GOST R 52544, CSA CAN 3 - N2872, ISO 15835, BS8110, DIN 1045, NF35-20-1, JGJ107.

**100%
BAR
BREAK**



TYPICAL TEST RESULTS

Nominal Bar Size Dia. mm	Yield Stress (N/mm ²)	Ultimate Stress (N/mm ²)	Tensile/Yield Stress Ratio	Elongation %	Failure Mode
16	465	587	1.26	18	Bar Break
20	466	596	1.28	20	Bar Break
25	488	625	1.28	18	Bar Break
32	479	604	1.26	20	Bar Break
40	495	629	1.27	18	Bar Break
50	518	669	1.29	17	Bar Break

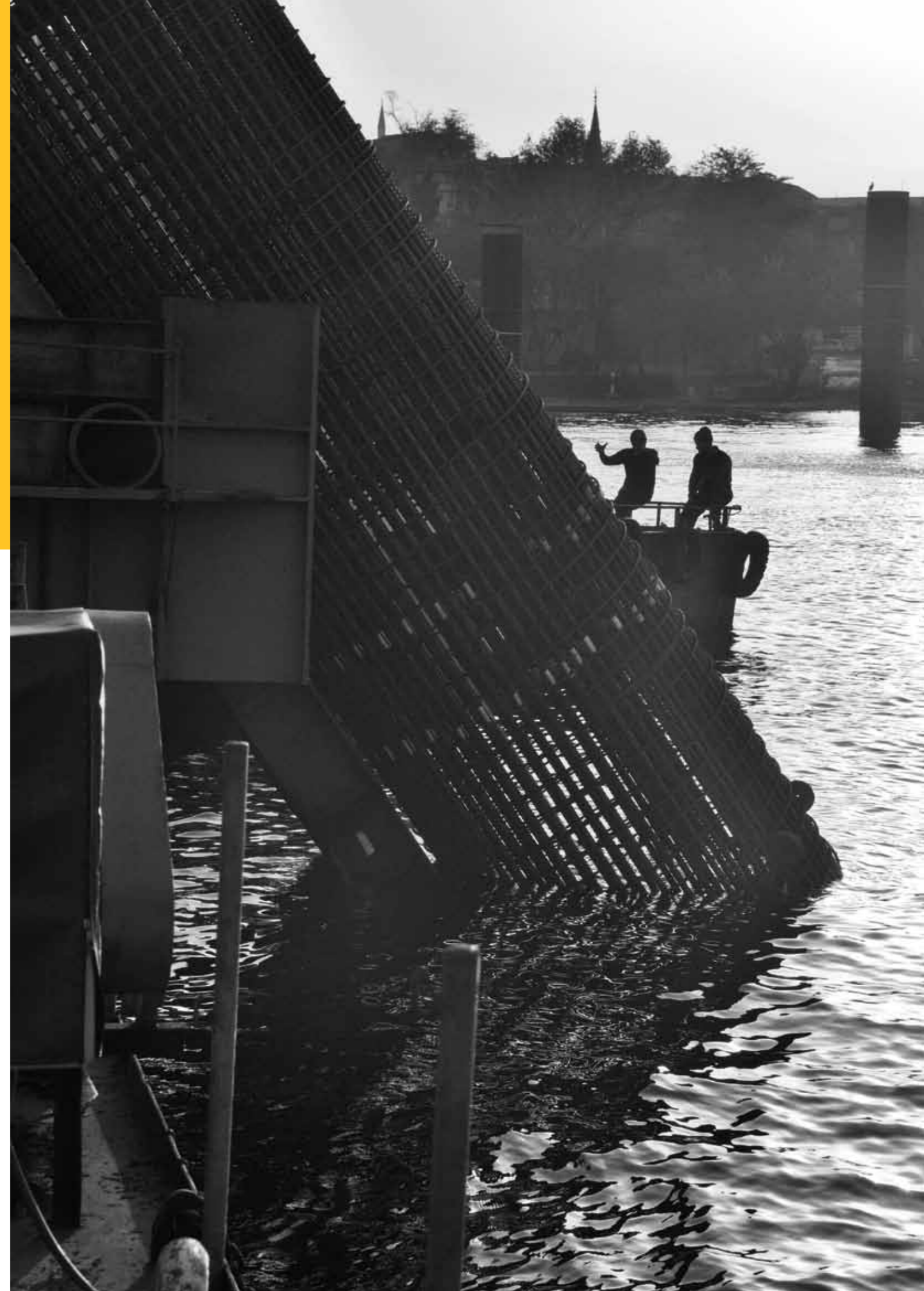
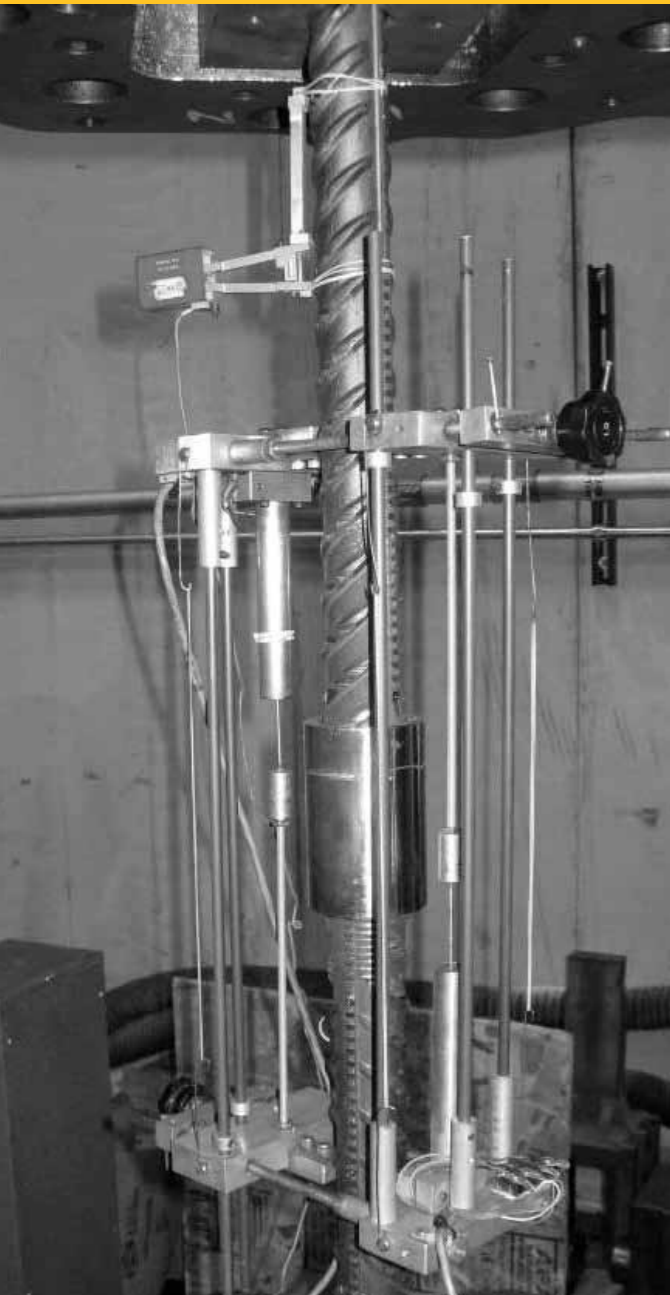



STRENGTH

provided by the coupler offers a solution for handling and moving massive reinforcing structures.

simGRIP™ system

UPSET PARALLEL THREAD MECHANICAL COUPLER FOR REINFORCING BARS

SimGrip™ System parallel threaded mechanical coupler is a steel sleeve which is internally threaded. SimGrip™ System couplers are used when joining deformed grade 460B and B500B reinforcing bars complying with BS4449, S420 and S500 reinforcing bars complying with TS708.

To better suit the couplers, the deformed high-yield carbon reinforcing bar ends are enlarged to a predetermined size with a cold forming press before cut or roll threading. This method provides a larger diameter of rebar ends for threading. Rebar ends enlarged and threaded by BARUS have no loss of cross-sectional areas. Parallel thread couplers are available in five types:

SimGrip™ Standard, SimGrip™ LT, SimGrip™ PS,
SimGrip™ Crossing, SimGrip™ TS



simGRIP™ standard

The SimGrip™ Standard is used in applications where the continuation bar can be rotated freely and is comprised of an internally threaded coupler with a single right hand thread. The ends of the bars are upset and threaded for half the length of the coupler.



simGRIP™ lt

The SimGrip™ LT System is used in applications where it is more difficult to rotate the continuation bar. It is comprised of the same coupler as the SimGrip™ System, however, one bar is threaded for a full coupler length.



simGRIP™ ps

The SimGrip™ PS System is a Position Type coupler is used where the continuation bar cannot be rotated and therefore includes an additional locknut. The continuation bar is threaded for the full coupler length plus the length of the locknut.



simGRIP™ crossing

The SimGrip™ Crossing System is used when the bars cannot be placed butt to butt in challenging rebar cages or difficult installations. Both bars are threaded with SimGrip™ System thread, and a Crossing Splice Set is used to connect two rebars mechanically.



simGRIP™ ts

The SimGrip™ Transition Coupler is used to splice different diameter reinforcing bars. The transition coupler comprises an internally threaded sleeve with two right hand threads. Spliced bars provide full strength in tension, compression and stress reversal applications and behave as continuous lengths of rebars. The diameter of each thread corresponds to the appropriate bar size.



Anchor-Nut™

The parallel threaded headed Anchor-Nut™ provides an alternative method of creating a simpler and more effective rebar end anchorage than the traditional hooked rebar within the concrete.



BEFORE

Openings to be closed in
Top Down Construction –
Shangri-La Hotel Project

AFTER

Closing of openings in
Top Down Construction –
Shangri-La Hotel Project



BARUS simGRIP™ system EQUIPMENTS

Machines and equipment provided are designed and manufactured by BARUS and have received CE and ISO 9001 quality certifications.

Equipment is packaged and shipped “shop ready” to operate and comes complete with a cold forging press, threading machine, band saw and grinding machine.

BARUS SimGrip™ equipment is usually located on the rebar supplier’s premises and the couplers are supplied pre-fixed to the threaded bar ends. For large projects where bar end preparation can be carried out onsite, equipment can be made available for hire.



BARUS Cold Upset Press. PLC controlled heavy duty hydraulic press. CE and ISO 9001 certified.



The BARUS method enlarges the rebar ends using a BARUS cold forging press. This method proves a larger diameter of rebar for threading. Rebar ends enlarged and threaded by BARUS have no loss of cross-sectional areas.

01 Cut end square

02 Rebar end enlarged by cold forging with BARUS cold forging press designed and manufactured for this purpose

03 Rebar end is cut threaded by BARUS bench threading machine, designed and manufactured for this purpose

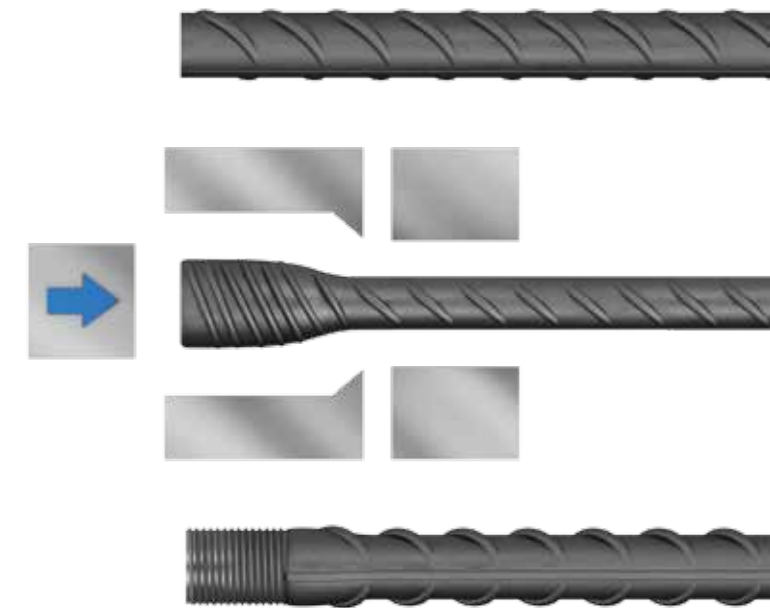

Rebar Roll Threading Machine



Tangential Rebar Threading Machine

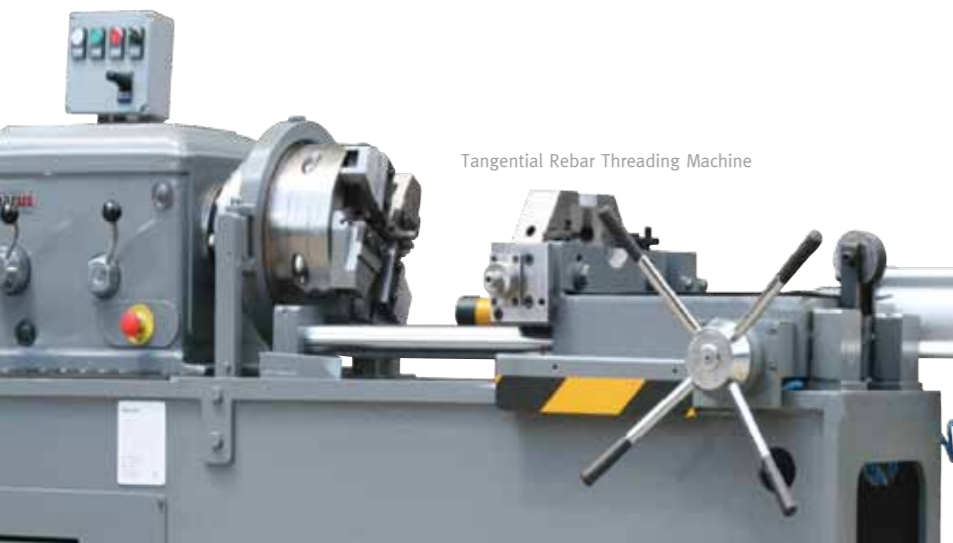

Threads on a non-upsetted rebar.



Threads on an upsetted rebar.

WHY UPSETTING?

Upsetting a system provides a larger diameter for the rebar end to be threaded. Rebar ends enlarged and threaded by BARUS have no loss of cross-sectional areas. Note the reduced cross-sectional area of the non-upsetted rebar.



CONTINUITY

of reinforcing bars is an added value in structures that are going to be lived in.



simGRIP™ standard

The SimGrip™ System is used in applications where the continuation bar can be rotated freely and is comprised of an internally threaded coupler with a single right hand thread. The ends of the bars are upset and threaded for half the length of the coupler.



simGRIP™ standard INSTALLATION

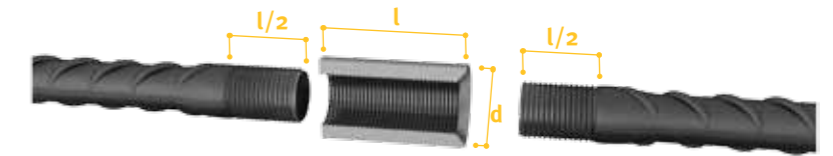

Bar Diameter	12	14	16	18	20	22	25	28	30	32	36	40	50
External Dia (d)(mm)	17	20	25	28	30	35	36	40	43	45	50	55	75
Coupler Length (l)(mm)	30	35	40	45	49	51	59	63	65	70	80	82	100
Thread Size (Metric)	M14x2,0	M16x2,0	M20x2,5	M22x2,5	M24x3,0	M27x3,0	M30x3,5	M33x3,5	M36x4,0	M36x4,0	M39x4,0	M45x4,5	M56x5,5
Color Code	Orange	Purple	Pink	Grass Green	Dark Green	White	Blue	Levander	Grey	Yellow	Brown	Red	Black
Weight (kg)	0.04	0.07	0.09	0.12	0.16	0.26	0.32	0.43	0.50	0.58	0.87	1.13	1.97
Product Code	SG12	SG14	SG16	SG18	SG20	SG22	SG25	SG28	SG30	SG32	SG36	SG40	SG50

Bar Diameter	#4	#5	#6	#7	#8	#9	#10	#11	#14	#18
External Dia (d)(inch)	5/8	1	1 1/8	1 3/8	1 3/8	1 5/8	1 6/8	2	2 3/8	3 3/8
Coupler Length (l)(inch)	1 1/8	1 5/8	1 7/8	2	2 3/8	2 4/8	2 6/8	3 1/8	3 4/8	4 4/8
Thread Size (UNC)	5/16-18	3/8-24	7/16-20	1/2-13	1/2-20	9/16-12	9/16-18	5/8-11	3/4-16	1"-14
Color Code	Orange	Pink	Dark Green	White	Blue	Levander	Yellow	Brown	Claret Red	Black
Weight (lbs)	0.09	0.20	0.35	0.57	0.71	0.95	1.28	1.92	2.68	4.95
Product Code	SGI#4	SGI#5	SGI#6	SGI#7	SGI#8	SGI#9	SGI#10	SGI#11	SGI#14	SGI#18

01

Screw the coupler onto the fixed bar until it hits the end of the threading and lock tight. The bar end should be centered within the coupler.



02

Remove the plastic caps from the coupler and rebar.

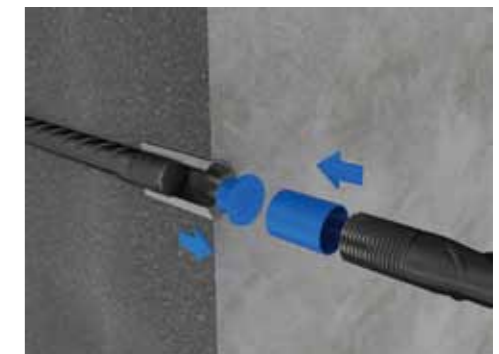

COATING OPTIONS

Epoxy coated mechanical couplers for splicing epoxy coated bars that comply with ASTM A775/A775M.

Hot dip galvanized mechanical couplers for splicing galvanized bars that comply with ASTM A767/A767M.

Stainless steel SimGrip™ couplers for splicing stainless steel bars and special use.

After tightening, there should be no more than 2-4 mm of thread exposed depending on the diameter of the rebar. Detailed visual control and quality assurance information are available upon request.

Contact BARUS for reusable accessories and waste-reducing products for LEED and environmentally friendly projects.

03

Attach the continuation bar into the coupler and rotate as far as the continuation bar will turn.

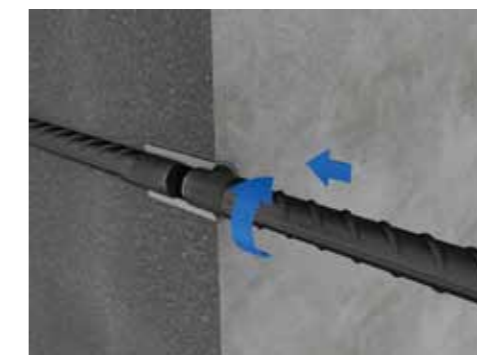

04

Tighten the joint using a wrench on the continuation bar.

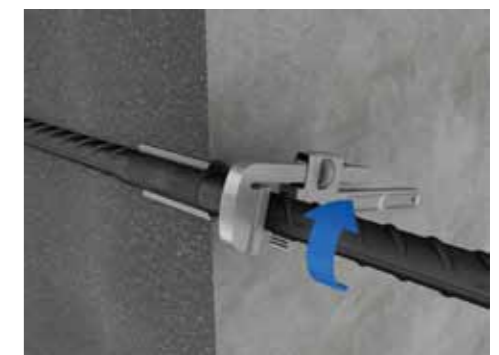



simGRIP™ Lt

The SimGrip™ LT System is used in applications where it is more difficult to rotate the continuation bar. It is comprised of the same coupler as the SimGrip™ System, however, one bar is threaded for a full coupler length.

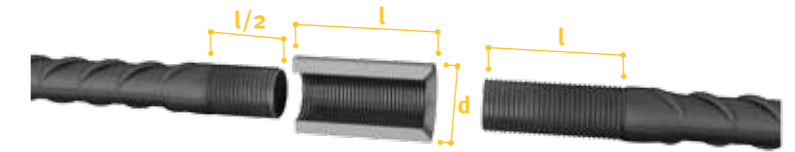

Metric Dimensions	Bar Diameter	12	14	16	18	20	22	25	28	30	32	36	40	50
	External Dia (d)(mm)	17	20	25	28	30	35	36	40	43	45	50	55	75
	Coupler Length (l)(mm)	30	35	40	45	49	51	59	63	65	70	80	82	100
	Thread Size (Metric)	M14x2,0	M16x2,0	M20x2,5	M22x2,5	M24x3,0	M27x3,0	M30x3,5	M33x3,5	M36x4,0	M36x4,0	M39x4,0	M45x4,5	M56x5,5
	Color Code	Orange	Purple	Pink	Grass Green	Dark Green	White	Blue	Levander	Grey	Yellow	Brown	Red	Black
	Weight (kg)	0.04	0.07	0.09	0.12	0.16	0.26	0.32	0.43	0.50	0.58	0.87	1.13	1.97
	Product Code	SGLT12	SGLT14	SGLT16	SGLT18	SGLT20	SGLT22	SGLT25	SGLT28	SGLT30	SGLT32	SGLT36	SGLT40	SGLT50

Imperial Dimensions	Bar Diameter	#4	#5	#6	#7	#8	#9	#10	#11	#14	#18
	External Dia (d)(inch)	5/8	1	1 1/8	1 3/8	1 3/8	1 5/8	1 6/8	2	2 3/8	3 3/8
	Coupler Length (l)(inch)	1 1/8	1 5/8	1 7/8	2	2 3/8	2 4/8	2 6/8	3 1/8	3 4/8	4 4/8
	Thread Size (UNC)	5/16-18	3/8-24	7/16-20	1/2-13	1/2-20	9/16-12	9/16-18	5/8-11	3/4-16	1"-14
	Color Code	Orange	Pink	Dark Green	White	Blue	Levander	Yellow	Brown	Claret Red	Black
	Weight (lbs)	0.09	0.20	0.35	0.57	0.71	0.95	1.28	1.92	2.68	4.95
	Product Code	SGLT#4	SGLT#5	SGLT#6	SGLT#7	SGLT#8	SGLT#9	SGLT#10	SGLT#11	SGLT#14	SGLT#18

01

Remove the plastic cap from the rebar.



COATING OPTIONS

Epoxy coated mechanical couplers for splicing epoxy coated bars that comply with ASTM A775/A775M.

Hot dip galvanized mechanical couplers for splicing galvanized bars that comply with ASTM A767/A767M.

Stainless steel SimGrip™ couplers for splicing stainless steel bars and special use.

02

Screw the coupler onto the fixed bar until it hits the end of the threading and lock tight. The bar end should be centered within the coupler.



03

Attach the continuation bar into the coupler and rotate as far as the continuation bar will turn.



04

Tighten the joint using a wrench on the continuation bar.



After tightening, there should be no more than 2-4 mm of thread exposed plus half the length of the coupler depending on the diameter of the rebar. Detailed visual control and quality assurance information are available upon request.

Contact BARUS for reusable accessories and waste-reducing products for LEED and environmentally friendly projects.

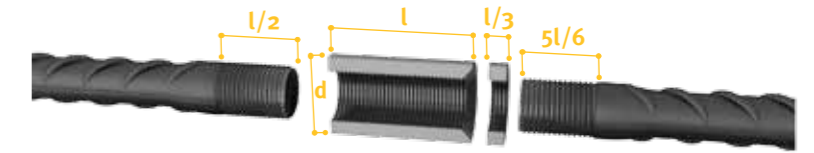

simGRIP™ ps

The SimGrip™ PS System is a Position Type coupler is used where the continuation bar cannot be rotated and therefore includes an additional locknut. The continuation bar is threaded for the full coupler length plus the length of the locknut. The SimGrip™ PS System couplers can be used with or without locknut.

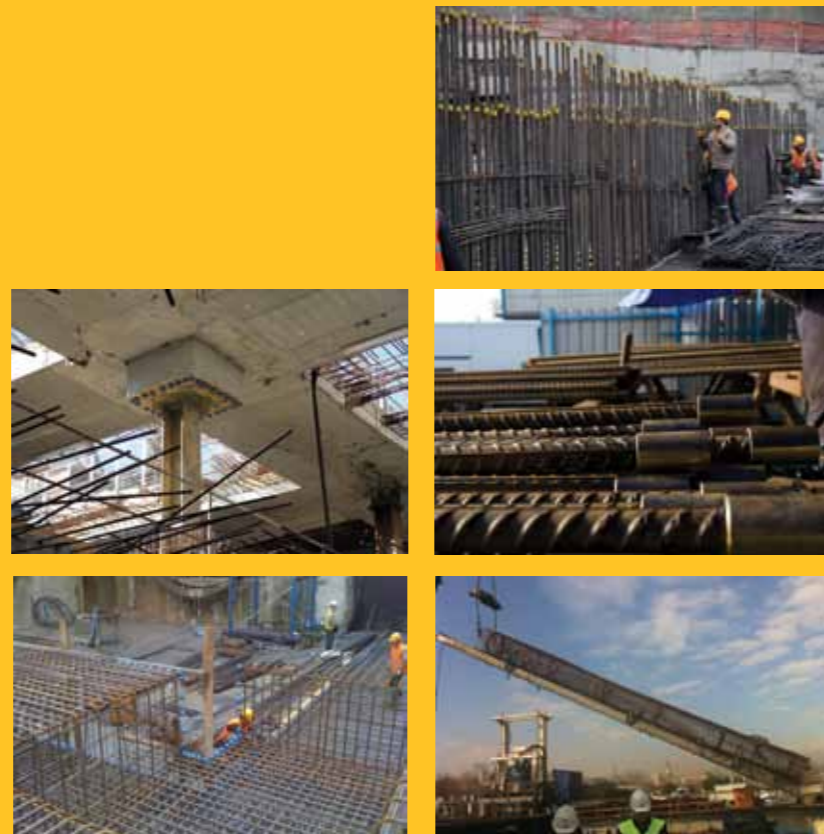

Metric Dimensions	Bar Diameter	12	14	16	18	20	22	25	28	30	32	36	40	50
	External Dia (d)(mm)	17	20	25	28	30	35	36	40	43	45	50	55	75
	Coupler Length (l)(mm)	30	35	40	45	49	51	59	63	65	70	80	82	100
	Thread Size (Metric)	M14x2,0	M16x2,0	M20x2,5	M22x2,5	M24x3,0	M27x3,0	M30x3,5	M33x3,5	M36x4,0	M36x4,0	M39x4,0	M45x4,5	M56x5,5
	Color Code	Orange	Purple	Pink	Grass Green	Dark Green	White	Blue	Levander	Grey	Yellow	Brown	Red	Black
	Weight (kg)	0.04	0.07	0.09	0.12	0.16	0.26	0.32	0.43	0.50	0.58	0.87	1.13	1.97
	Product Code	SGLT12	SGLT14	SGLT16	SGLT18	SGLT20	SGLT22	SGLT25	SGLT28	SGLT30	SGLT32	SGLT36	SGLT40	SGLT50
	Imperial Dimensions	Bar Diameter	#4	#5	#6	#7	#8	#9	#10	#11	#14	#18		
		External Dia (d)(inch)	5/8	1	1 1/8	1 3/8	1 3/8	1 5/8	1 6/8	2	2 3/8	3 3/8		
		Coupler Length (l)(inch)	1 1/8	1 5/8	1 7/8	2	2 3/8	2 4/8	2 6/8	3 1/8	3 4/8	4 4/8		
Thread Size (UNC)		5/16-18	3/8-24	7/16-20	1/2-13	1/2-20	9/16-12	9/16-18	5/8-11	3/4-16	1"-14			
Color Code		Orange	Pink	Dark Green	White	Blue	Levander	Yellow	Brown	Claret Red	Black			
Weight (lbs)		0.09	0.20	0.35	0.57	0.71	0.95	1.28	1.92	2.68	4.95			
Product Code		SGLT#4	SGLT#5	SGLT#6	SGLT#7	SGLT#8	SGLT#9	SGLT#10	SGLT#11	SGLT#14	SGLT#18			

01

Remove the BARUS concrete spacer plug and rebar thread protector.



02

Attach the locknut then the coupler to continuation bar with the coupler against the end of the first bar.

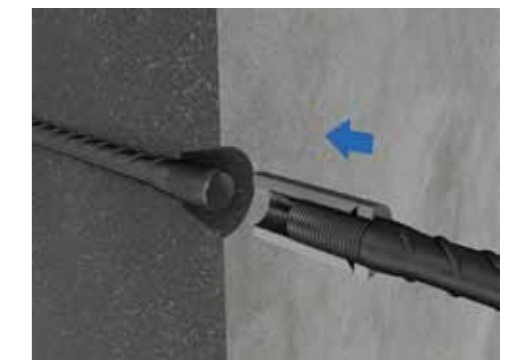

COATING OPTIONS

Epoxy coated mechanical couplers for splicing epoxy coated bars that comply with ASTM A775/A775M.

Hot dip galvanized mechanical couplers for splicing galvanized bars that comply with ASTM A767/A767M.

Stainless steel SimGrip™ couplers for splicing stainless steel bars and special use.

After tightening, there should be no more than 2-4 mm of thread exposed depending on the diameter of the rebar. Detailed visual control and quality assurance information are available upon request.

Contact BARUS for reusable accessories and waste-reducing products for LEED and environmentally friendly projects.

03

Screw the coupler from the continuation bar and rotate until it hits the end of the threading on the opposing bar and lock tight.

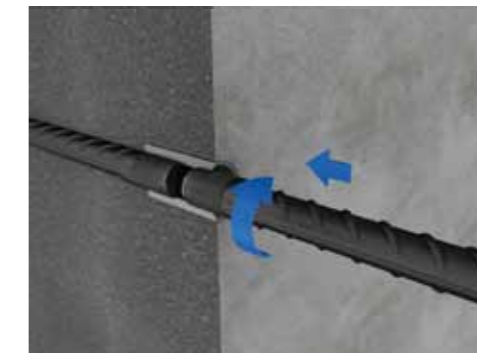

04

Hold the bent rebar in its required orientation and tighten the locknut against the coupler with a wrench.

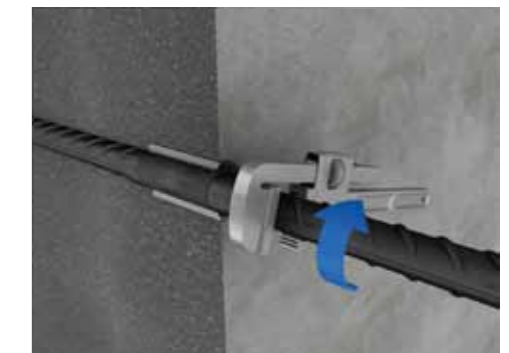



simGRIP[™] crossing

The SimGrip[™] Crossing System is used when the bars cannot be placed butt to butt in challenging rebar cages or difficult installations. Both bars are threaded with SimGrip[™] System thread, and a Crossing Splice Set is used to connect two rebars mechanically.



simGRIP[™] crossing INSTALLATION

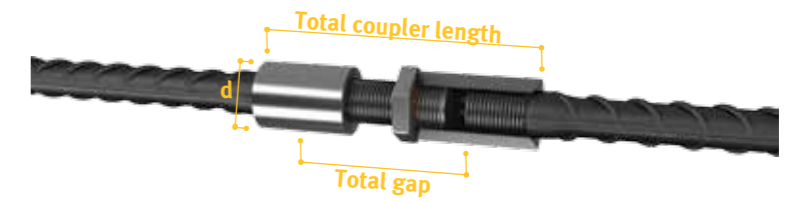

Metric Dimensions	Bar Diameter	12	14	16	18	20	22	25	28	30	32	36	40	50
	External Dia (mm)	17	20	25	28	30	35	36	40	43	45	50	55	75
	Total Coupler Length (mm)	30	35	40	45	49	51	59	63	65	70	80	82	100
	Total Gap (mm)	79	96	106	126	144	161	186	210	218	228	268	290	310
	Thread Size (Metric)	M14x2,0	M16x2,0	M20x2,5	M22x2,5	M24x3,0	M27x3,0	M30x3,5	M33x3,5	M36x4,0	M36x4,0	M39x4,0	M45x4,5	M56x5,5
Color Code	Orange	Purple	Pink	Grass Green	Dark Green	White	Blue	Levander	Grey	Yellow	Brown	Red	Black	
Weight (kg)	0.04	0.07	0.09	0.12	0.16	0.26	0.32	0.43	0.5	0.58	0.87	1.13	1.97	
Product Code	SGPS12	SGPS14	SGPS16	SGPS18	SGPS20	SGPS22	SGPS25	SGPS28	SGPS30	SGPS32	SGPS36	SGPS40	SGPS50	

Imperial Dimensions	Bar Diameter	#4	#5	#6	#7	#8	#9	#10	#11	#14	#18
	External Dia (inch)	5/8	1	1 1/8	1 3/8	1 3/8	1 5/8	1 6/8	2	2 3/8	3 3/8
	Coupler Length (inch)	1 1/8	1 5/8	1 7/8	2	2 3/8	2 4/8	2 6/8	3 1/8	3 4/8	4 4/8
	Total Gap (mm)	3 1/8	4 1/8	5 5/8	6 3/8	7 3/8	8 5/8	9	10 4/8	12 5/8	16 6/8
	Thread Size (UNC)	5/16-18	3/8-24	7/16-20	1/2-13	1/2-20	9/16-12	9/16-18	5/8-11	3/4-16	1"-14
	Color Code	Orange	Pink	Dark Green	White	Blue	Levander	Yellow	Brown	Claret Red	Black
	Weight (lbs)	0.09	0.20	0.35	0.57	0.71	0.95	1.28	1.92	2.68	4.95
Product Code	SGPSI#4	SGPSI#5	SGPSI#6	SGPSI#7	SGPSI#8	SGPSI#9	SGPSI#10	SGPSI#11	SGPSI#14	SGPSI#18	

COATING OPTIONS

Epoxy coated mechanical couplers for splicing epoxy coated bars that comply with ASTM A775/A775M.

Hot dip galvanized mechanical couplers for splicing galvanized bars that comply with ASTM A767/A767M.

Stainless steel SimGrip[™] couplers for splicing stainless steel bars and special use.

After tightening, there should be no more than 2-4 mm of thread exposed plus half the length of the coupler depending on the diameter of the rebar. Detailed visual control and quality assurance information are available upon request.

Contact BARUS for reusable accessories and waste-reducing products for LEED and environmentally friendly projects.

01

Bring the first bar as close as possible to the continuation bar.



02

Screw the bridging coupler out of the female bridging assembly set and onto the bottom bar.



03

Screw the nut out of the female bridging assembly set and as close as possible to the bridging coupler. Tighten the female bridging stud, bridging couple and lock nut respectively.

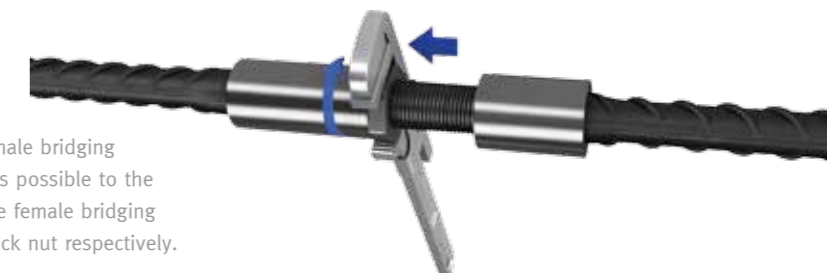



simGRIP™ ts

The SimGrip™ TS is used to splice different diameter reinforcing bars. The transition coupler comprises an internally threaded sleeve with two right hand threads. Spliced bars provide full strength in tension, compression and stress reversal applications and behave as continuous lengths of rebars. The diameter of each thread corresponds to the appropriate bar size.



INFORMATION ABOUT simGRIP™ ts

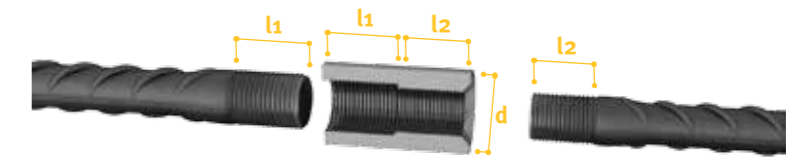

Bar Diameter	14-12	18-16	20-16	26-20	26-22	28-20	28-22	28-26	30-26	32-26	32-28	40-32	50-40
External Dia (d)(mm)	20	28	30	36	36	40	40	36	43	45	45	55	75
Coupler Length (l)(mm)	35	45	46	53	60	51	59	63	65	70	74	82	82
Color Code	Orange	Purple	Pink	Grass Green	Dark Green	White	White	Blue	Levander	Grey	Yellow	Brown	Red
Weight (kg)	0.13	0.20	0.23	0.29	0.32	0.42	0.44	0.45	0.56	0.58	0.60	0.88	1.00
Product Code	SGTS14-12	SGPS18-16	SGPS20-16	SGPS26-20	SGPS26-22	SGPS28-20	SGPS28-22	SGPS28-26	SGPS30-26	SGPS32-26	SGPS32-28	SGPS40-32	SGPS50-40

Bar Diameter	#4	#5	#6	#7	#8	#9	#10	#11	#14	#18
External Dia (d)(inch)	5/8	1	1 1/8	1 3/8	1 3/8	1 5/8	1 6/8	2	2 3/8	3 3/8
Coupler Length (l)(inch)	1 1/8	1 5/8	1 7/8	2	2 3/8	2 4/8	2 6/8	3 1/8	3 4/8	4 4/8
Thread Size (UNC)	5/16-18	3/8-24	7/16-20	1/2-13	1/2-20	9/16-12	9/16-18	5/8-11	3/4-16	1"-14
Color Code	Orange	Pink	Dark Green	White	Blue	Levander	Yellow	Brown	Claret Red	Black
Weight (lbs)	0.09	0.20	0.35	0.57	0.71	0.95	1.28	1.92	2.68	4.95
Product Code	SGLT#4	SGLT#5	SGLT#6	SGLT#7	SGLT#8	SGLT#9	SGLT#10	SGLT#11	SGLT#14	SGLT#18

COATING OPTIONS

Epoxy coated mechanical couplers for splicing epoxy coated bars that comply with ASTM A775/A775M.

Hot dip galvanized mechanical couplers for splicing galvanized bars that comply with ASTM A767/A767M.

Stainless steel SimGrip™ couplers for splicing stainless steel bars and special use.

SimGrip™ TS is a transition type mechanical coupler used to join reinforcing bars of different diameters. The coupler is normally supplied fixed to a reinforcing bar, ready to be installed and cast in concrete.

SimGrip™ TS coupler comprises an internally threaded sleeve with two righthand parallel threads centered in the middle of the coupler. Spliced bars provide full strength in tension, compression and stress reversal applications and behave as continuous lengths of rebars. Thus structural integrity is procured.

In tension test, bar break occurs on smaller reinforcing bar.

It is allowable also, in most cases, to reduce the size of the larger bar and to use a standard coupler.

After tightening, there should be no more than 2-4 mm of thread exposed depending on the diameter of the rebar. Detailed visual control and quality assurance information are available upon request.

Contact BARUS for reusable accessories and waste-reducing products for LEED and environmentally friendly projects.

EFFICIENCY





LARGE ROUND REBAR HEADS, ANX10

Bar Diameter	12	14	16	18	20	22	25	28	30	32	36	40	50
External Dia (d)(mm)	42	48	52	59	65	73	85	95	43	105	120	130	150
Thickness (mm)	15	17.5	20	22.5	24.5	25.5	29.5	31.5	32.5	35	40	41	50
Thread Size (Metric)	M14x2,0	M16x2,0	M20x2,5	M22x2,5	M24x3,0	M27x3,0	M30x3,5	M33x3,5	M36x4,0	M36x4,0	M39x4,0	M45x4,5	M56x5,5
Surface Ratio	> 9	> 9	> 9	> 9	> 9	> 9	> 9	> 9	> 9	> 9	> 9	> 9	> 9
Color Code	Orange	Purple	Pink	Grass Green	Dark Green	White	Blue	Levander	Grey	Yellow	Brown	Red	Black
Weight (kg)	0.04	0.07	0.09	0.12	0.16	0.26	0.32	0.43	0.5	0.58	0.87	1.13	1.97
Product Code	SGAN12	SGAN14	SGAN16	SGAN18	SGAN20	SGAN22	SGAN25	SGAN28	SGAN30	SGAN32	SGAN36	SGAN40	SGAN50

Bar Diameter	#4	#5	#6	#7	#8	#9	#10	#11	#14	#18
External Dia (d)(inch)	1 5/8	2	2 4/8	2 7/8	3 3/8	1 6/8	4 1/8	4 6/8	6 4/8	8 7/8
Thickness (inch)	5/8	6/8	1	1	1 1/8	1 2/8	1 3/8	1 5/8	2 1/8	3
Thread Size (UNC)	5/16-18	3/8-24	7/16-20	1/2-13	1/2-20	9/16-12	9/16-18	5/8-11	3/4-16	1"-14
Surface Ratio	> 9	> 9	> 9	> 9	> 9	> 9	> 9	> 9	> 9	> 9
Color Code	Orange	Pink	Dark Green	White	Blue	Levander	Yellow	Brown	Claret Red	Black
Weight (lbs)	0.09	0.20	0.35	0.57	0.71	0.95	1.28	1.92	2.68	4.95
Product Code	SGANI#4	SGANI#5	SGANI#6	SGANI#7	SGANI#8	SGANI#9	SGANI#10	SGANI#11	SGANI#14	SGANI#18

Anchor-Nut™ The parallel threaded headed Anchor-Nut™ provides an alternative method of creating a simpler and more effective rebar end anchorage than the traditional hooked rebar within the concrete.



COATING OPTIONS

Epoxy coated mechanical couplers for splicing epoxy coated bars that comply with ASTM A775/A775M.

Hot dip galvanized mechanical couplers for splicing galvanized bars that comply with ASTM A767/A767M.

Stainless steel SimGrip™ couplers for splicing stainless steel bars and special use.

After tightening, there should be no more than 2-4 mm of thread exposed depending on the diameter of the rebar. Detailed visual control and quality assurance information are available upon request.

Contact BARUS for reusable accessories and waste-reducing products for LEED and environmentally friendly projects.

BARUS Anchor-Nut™ is an easy to install and structurally improved rebar anchorage system that replaces hooked rebars in concrete based on the principles of the Shear Cone Theory used by ACI-355.

Traditionally, anchorage of rebars within a concrete section is done by creating long hooked ends on the rebar. BARUS Anchor-Nut™ creates an anchorage in the concrete, transmitting the bond force from the rebar to the concrete by a combination of head-bearing and development length. Anchor-Nut™ can simplify scheduling and bar placement as well as reduce congestion and air pockets in the concrete.

By using headed mechanical end anchors, hook bars are eliminated and rebar congestion is minimized resulting in improved space for pouring and vibrating, thereby enhancing concrete consolidation, lowering concrete placement costs, and improving in-place concrete quality. When using reinforcing bars with headed ends, the load reaction between the rebar and concrete is evenly distributed.

Custom designed for use on #4 (12 mm) to #8 (57 mm) reinforcing bars, BARUS Anchor-Nut™ creates a full length splice with the mode of failure being bar break. BARUS Anchor-Nut™ is designed to exceed the strength requirements of ACI 318, Section 12.6 or 100% of the Specified Yield Strength of Grade 60 bar.



BENEFITS OF BARUS Anchor-Nut™

- Standard threads and upset threads alternatives
- Pre-installed – saves field labor
- Easy placement
- Simplifies fabrication
- Eliminates rebar hook
- No special bend direction – less confusion
- Minimal detailing – more design flexibility
- No bending and cracking of bars
- No welding or hot forging – no heat
- Saves space and reduces member size
- Reduces congestion
- Improved job site safety
- Reduces bar bond slip

SOME POTENTIAL HOOK BAR PROBLEMS YOU CAN AVOID BY USING BARUS Anchor-Nut™

When a tensile load is applied to a hooked bar embedded in concrete, a complex stress pattern is generated on the inside radius of the bent bar. Most likely, the bar tends to straighten and cause splitting of the concrete cover in the plane of the hook. At the same time, there is a high risk of concrete crushing beneath a bent anchorage. The primary objective of architects and engineers is to minimize structural element size. Building code requirements for hooked bars can compromise such objectives. Utilizing hooked bars will result in steel congestion, making the fabrication and construction more complicated. Geometric limitations often prevent the use of larger diameter reinforcing bars due to construction limitations arising from lengthy hook extensions and large bend diameters. If spalling of concrete cover occurs around the leg of a hook bar, by fire, corrosion or another mechanism, the effectiveness of the hook is severely compromised.

STRUCTURAL SOLUTIONS

simGRIP™ weldable

The SimGrip™ Weldable is similar to the SimGrip™ standard coupler, however only half of one end is internally threaded and the other end is prepared for welding. These couplers are machined from weldable grades of material depending on rebar size conform to ASME Section III Division 2.

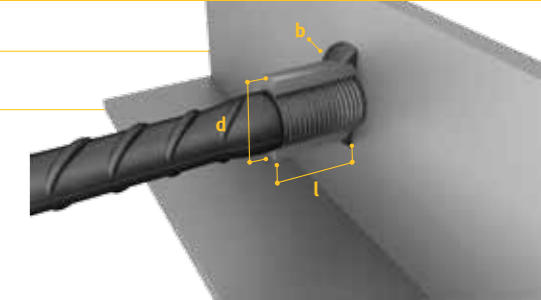

Metric Dimensions	Bar Diameter	12	14	16	18	20	22	25	28	30	32	36	40	50
	External Dia (mm)	17	20	25	28	30	35	36	40	43	45	50	55	75
	Coupler Length (mm)	35	40	45	50	54	56	64	68	70	75	85	87	110
	Thread Size (Metric)	M14x2,0	M16x2,0	M20x2,5	M22x2,5	M24x3,0	M27x3,0	M30x3,5	M33x3,5	M36x4,0	M36x4,0	M39x4,0	M45x4,5	M56x5,5
	Color Code	Orange	Purple	Pink	Grass Green	Dark Green	White	Blue	Levander	Grey	Yellow	Brown	Red	Black
	Weight (kg)	0.04	0.07	0.09	0.12	0.16	0.26	0.32	0.43	0.5	0.58	0.87	1.13	1.97
	Product Code	SGWD12	SGWD14	SGWD16	SGWD18	SGWD20	SGWD22	SGWD25	SGWD28	SGWD30	SGWD32	SGWD36	SGWD40	SGWD50

Imperial Dimensions	Bar Diameter	#4	#5	#6	#7	#8	#9	#10	#11	#14	#18
	External Dia (inch)	5/8	1	1 1/8	1 3/8	1 3/8	1 5/8	1 6/8	2	2 3/8	3 3/8
	Coupler Length (inch)	1 3/8	1 6/8	2 1/8	2 2/8	2 4/8	2 5/8	3	3 3/8	4 5/8	6 2/8
	Thread Size (UNC)	5/16-18	3/8-24	7/16-20	1/2-13	1/2-20	9/16-12	9/16-18	5/8-11	3/4-16	1"-14
	Color Code	Orange	Pink	Dark Green	White	Blue	Levander	Yellow	Brown	Claret Red	Black
	Weight (lbs)	0.09	0.20	0.35	0.57	0.71	0.95	1.28	1.92	2.68	4.95
	Product Code	SGWDI#4	SGWDI#5	SGWDI#6	SGWDI#7	SGWDI#8	SGWDI#9	SGWDI#10	SGWDI#11	SGWDI#14	SGWDI#18

simGRIP™ bolcon

SimGrip™ couplers are used to unite rebars to a metal object through an 8.8 heavy duty bolt.

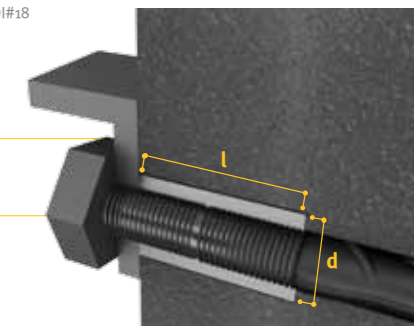

Metric Dimensions	Bar Diameter	12	14	16	18	20	22	25	28	30	32	36	40	50
	External Dia (mm)	21	25	26	30	32	36	40	45	49	50	57	62	77
	Coupler Length (mm)	35	40	45	50	54	56	64	66	70	72	84	90	112
	Thread Size (Metric)	M14x2,0	M16x2,0	M20x2,5	M22x2,5	M24x3,0	M27x3,0	M30x3,5	M33x3,5	M36x4,0	M36x4,0	M39x4,0	M45x4,5	M56x5,5
	Color Code	Orange	Purple	Pink	Grass Green	Dark Green	White	Blue	Levander	Grey	Yellow	Brown	Red	Black
	Weight (kg)	0.04	0.07	0.09	0.12	0.16	0.26	0.32	0.43	0.5	0.58	0.87	1.13	1.97
	Product Code	SGBC12	SGBC14	SGBC16	SGBC18	SGBC20	SGBC22	SGBC25	SGBC28	SGBC30	SGBC32	SGBC36	SGBC40	SGBC50

Imperial Dimensions	Bar Diameter	#4	#5	#6	#7	#8	#9	#10	#11	#14	#18
	External Dia (inch)	7/8	1	1 2/8	1 3/8	1 5/8	1 6/8	2	2 2/8	3 1/8	4 1/8
	Coupler Length (inch)	1 3/8	1 6/8	2 1/8	2 2/8	2 4/8	2 5/8	2 7/8	3 2/8	4 4/8	6 1/8
	Thread Size (UNC)	5/16-18	3/8-24	7/16-20	1/2-13	1/2-20	9/16-12	9/16-18	5/8-11	3/4-16	1"-14
	Color Code	Orange	Pink	Dark Green	White	Blue	Levander	Yellow	Brown	Claret Red	Black
	Weight (lbs)	0.09	0.20	0.35	0.57	0.71	0.95	1.28	1.92	2.68	4.95
	Product Code	SGBCI#4	SGBCI#5	SGBCI#6	SGBCI#7	SGBCI#8	SGBCI#9	SGBCI#10	SGBCI#11	SGBCI#14	SGBCI#18



TAPERED THREAD MECHANICAL COUPLER FOR REINFORCING BARS

TTEX™ System is a taper threaded mechanical coupler comprised of a steel sleeve which is internally threaded with a single right hand thread. The ends of bars are taper threaded. TTEX™ family of tapered thread mechanical couplers requires a BARUS taper threading machine.

To better suit the couplers, the deformed high-yield carbon reinforcing are directly threaded with a taper threading machine. Bar ends are in flattened case of necessity. At the end of the process, rebar ends have no loss of cross-sectional areas. Taper threaded couplers are available in five types:

TTEX™ Standard, TTEX™ TS, TTEX™ PS, TTEX™ Anchor-Nut, and TTEX™ Weldable

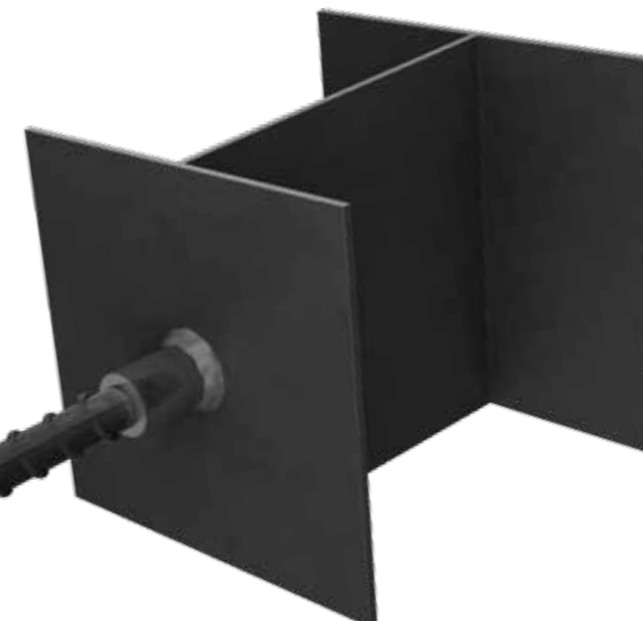

TTEX standard

The TTEX™ System is used in applications where the continuation bar can be rotated freely and is comprised of an internally threaded coupler with a single right hand thread. The ends of the bars are taper threaded for half the length of the coupler.

TTEX ts

The TTEX™ Transition Coupler is used to splice different diameter reinforcing bars. The transition coupler comprises an internally threaded sleeve with two right hand threads. Spliced bars provide full strength in tension, compression and stress reversal applications and behave as continuous lengths of rebars. The diameter of each thread corresponds to the appropriate bar size.

TTEX ps

The TTEX™ PS System is a Position Type coupler is used where the continuation bar cannot be rotated and therefore includes an additional locknut. The continuation bar is threaded for the full coupler length plus the length of the locknut.

TTEX anchor nut

The taper threaded headed Anchor-Nut™ provides an alternative method of creating a simpler and more effective rebar end anchorage than the traditional hooked rebar within the concrete.

TTEX weldable

The TTEX™ Weldable is similar to the TTEX™ standard coupler, however only half of one end is internally threaded and the other end is prepared for welding. These couplers are machined from weldable grades of material depending on rebar size conform to ASME Section III Division 2



FAST TRACK

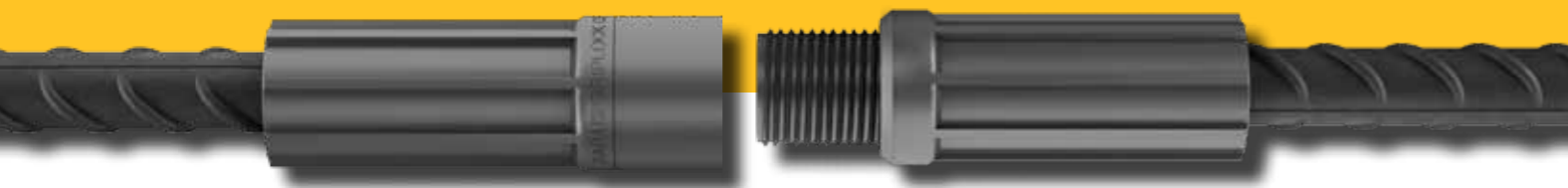

BENEFITS OF SWAGE SYSTEM COUPLERS

Due to the growing technical challenges faced in today's construction industry, traditional methods for connecting rebar, such as lapping or welding, is no longer the best method to connect rebar. More and more construction codes are specifying a mechanical coupler because it provides better structural integrity while minimizing costs. Some of the benefits of using a BARUS mechanical coupler include:

- **More reliable and more structural integrity than lap splices because they no longer rely on the concrete for load transfer**
- **Reduces the amount of rebar, which reduces the labor and crane time – improving the construction schedule**
- **Lower risk of rock and air pockets by reducing rebar congestion**
- **No lapping length necessary – reduces inventory which lowers cost**
- **Efficient and easy design options result in smaller and stronger columns with the maximum amount of useful area**
- **Better splice inspection – lowers quality control costs**
- **Avoids drilling and/or cutting forms, especially in crane, elevator openings, and stairwells**
- **Allows for same line splicing – no staggered splices**
- **Installs easily and quickly**
- **Minimizes rebar waste**



griplock sl

GripLock SL is a sleeve type coupler that slips over the ends of deformed reinforcing bars and swaged with a BARUS portable press to produce a mechanical interlock between the deformed rebar profile and the sleeve coupler.



griplock fm

GripLock FM is a two-piece male/female (M+F) swaging system utilizing a mechanical coupler to splice deformed reinforcing bars. The coupler is swaged onto the bar with a BARUS bench press before installation. No equipment is needed in-situ.



griplock ps

GripLock PS is a position coupler with a short threaded stud between two female GripLock couplers. It is used for applications where bars can not be rotated or it is not practical to rotate the bars due to bent bars, pile installations to engage the threads or when bars are too long and heavy.



griplock crossing

GripLock Crossing Coupler System comprises a long threaded stud between two female GripLock couplers. It is used when the bars cannot be placed butt to butt in challenging rebar cages or difficult installations.

griplock system

SWAGE TYPE MECHANICAL COUPLER FOR REINFORCING BARS

The GripLock cold swaging system uses a mechanical coupler to splice deformed reinforcing bars. The GripLock coupler is swaged onto the reinforcing bars by using a swaging press and die to deform the coupler sleeve onto the rebar profile. This produces a secure mechanical interlock between the profile of the reinforcing bar and the coupler. Tensile testing results show that the strength of the GripLock mechanical splice is greater than the strength of the bar itself. Where access is limited or geometry is problematic, two or three-part threaded sleeves can be used. GripLock systems are fast, economic and easy to install.

Swage type mechanical couplers are available in five types: **GripLock FM, Griolock SL, Griplock TS, Griplock PS, and Griplock Crossing**

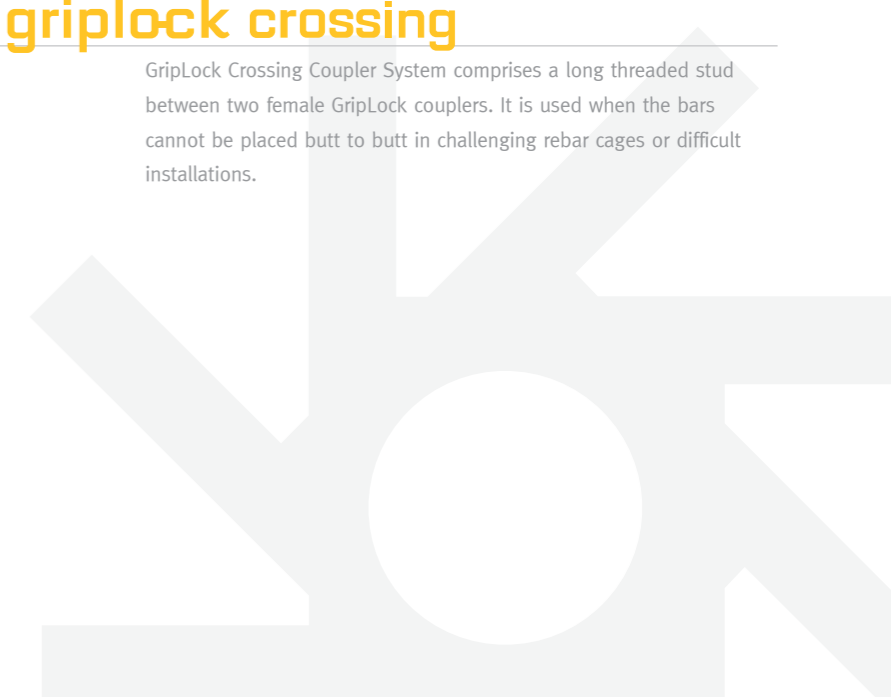

BARUS griplock system EQUIPMENTS

BARUS designs and manufactures heavy duty customized machines like upset presses, bench and portable swaging presses, and threading machines for use with our mechanical couplers.

All BARUS equipments are designed for both shop and outdoor field use. Our equipment is heavy duty and built to the highest quality standards to ensure that they will consistently perform and produce superior results for your large scale and mega size projects.

All of our equipment are CE certified, which means you can be confident that our equipment comply with all relevant essential requirements related to safety, health, and environmental protection.

Contact BARUS for assistance to decide best equipment with your application.

BARUS Swaging Equipments for Griplock™ System Mechanical Couplers

GripLock™ Bench and Portable swaging equipments are easy to use and may be leased or purchased. Splicing manuals provided with equipment explain step-by-step installation and safety information. Equipment must be used in accordance with manuals, lease agreements, manufacturer's directions and all safety instructions.

Swaging dies are stamped and color coded to match the coupling sleeves.



BARUS Portable type Cold Swaging Press
Model OMUR P1036

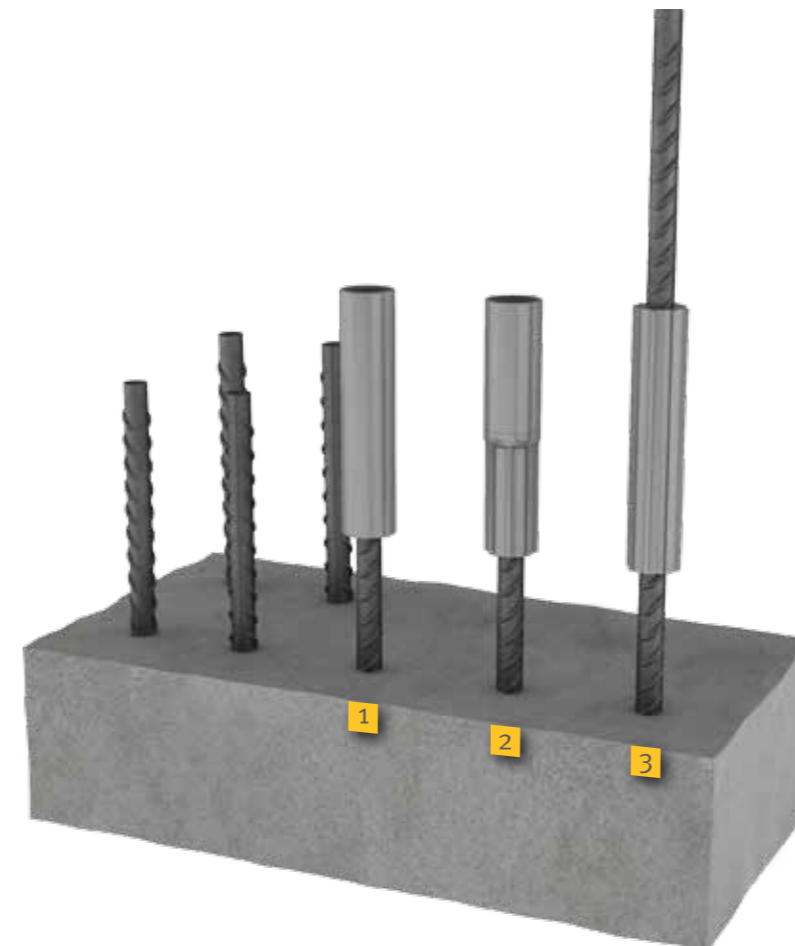

Detailed method statement documents enable exact connections.



BARUS Portable type Cold Swaging Press
Model OMUR P1036



BARUS Bench type Cold Swaging Press
Model EGE B1240



One part of the Griplock FM coupler family is Griplock Female coupler which can be delivered pre-pressed.

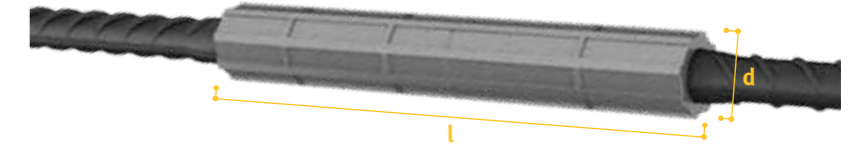

Metric Dimensions	12	14	16	18	20	22	25	28	30	32	36	40	50
Bar Diameter	12	14	16	18	20	22	25	28	30	32	36	40	50
External Dia (mm)	24	26	29	31	35	40	44	49	56	56	60	70	79
Coupler Length (mm)	70	75	80	90	100	115	135	150	170	170	190	220	280
Color Code	Orange	Purple	Pink	Grass Green	Dark Green	White	Blue	Levander	Grey	Yellow	Brown	Red	Black
Weight (kg)	0.06	0.08	0.11	0.14	0.19	0.29	0.37	0.5	0.59	0.65	0.93	1.22	2.05
Product Code	GLSL12	GLSL14	GLSL16	GLSL18	GLSL20	GLSL22	GLSL25	GLSL28	GLSL30	GLSL32	GLSL36	GLSL40	GLSL50

Imperial Dimensions	#4	#5	#6	#7	#8	#9	#10	#11	#14	#18
Bar Diameter	#4	#5	#6	#7	#8	#9	#10	#11	#14	#18
External Dia (inch)	1	1 1/8	1 3/8	1 5/8	1 6/8	2 2/8	2 2/8	2 3/8	3 1/8	4
Coupler Length (inch)	2 6/8	3 1/8	3 7/8	4 4/8	5 3/8	6 6/8	6 6/8	7 4/8	10	14 3/8
Color Code	Orange	Pink	Dark Green	White	Blue	Levander	Yellow	Brown	Claret Red	Black
Weight (lbs)	0.13	0.18	0.24	0.31	0.42	0.64	0.82	1.10	1.40	1.63
Product Code	GLSL#4	GLSL#5	GLSL#6	GLSL#7	GLSL#8	GLSL#9	GLSL#10	GLSL#11	GLSL#14	GLSL#18

gripllock sl

GripLock SL is a sleeve type coupler that slips over the ends of deformed reinforcing bars and swaged with a Bar-us portable press to produce a mechanical interlock between the deformed rebar profile and the sleeve coupler.



COATING OPTIONS

Epoxy coated mechanical couplers for splicing epoxy coated bars that comply with ASTM A775/A775M.

Hot dip galvanized mechanical couplers for splicing galvanized bars that comply with ASTM A767/A767M.

Stainless steel Griplock swaging couplers for splicing stainless steel bars and special use.

After tightening, there should be no more than 2-4 mm of thread exposed plus half the length of the coupler depending on the diameter of the rebar. Detailed visual control and quality assurance information are available upon request.

Contact BARUS for reusable accessories and waste-reducing products for LEED and environmentally friendly projects.

Align the bars and swage the Griplock SL coupler onto the reinforcing bars by using a portable swaging press and die to deform the coupler sleeve onto the rebar ribs.



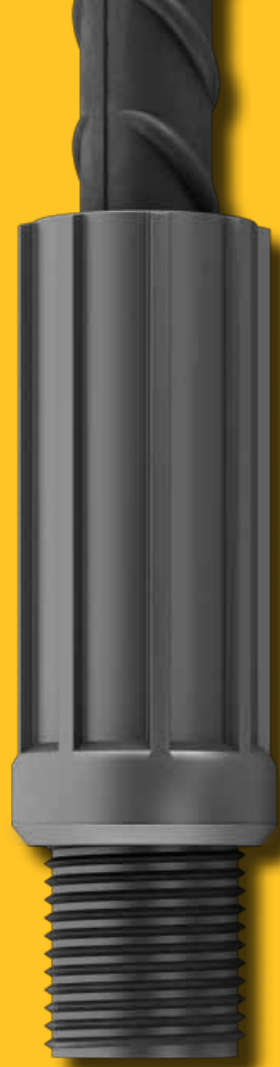

griplock fm

GripLock FM is a two-piece male/female (M+F) swaging system utilizing a mechanical coupler to splice deformed reinforcing bars. The coupler is swaged onto the bar with a BARUS bench press before installation. No equipment is needed in-situ.



griplock fm INSTALLATION

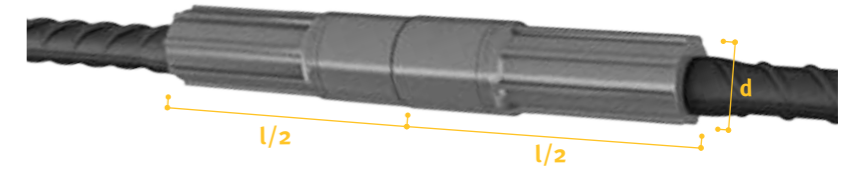

Metric Dimensions	Bar Diameter	12	14	16	18	20	22	25	28	30	32	36	40	50
	External Dia (mm)	24	26	29	31	35	40	44	49	56	56	60	70	79
	Splice Length (mm)	72	77	82	92	103	117	138	152	173	173	193	224	285
	Color Code	Orange	Purple	Pink	Grass Green	Dark Green	White	Blue	Levander	Grey	Yellow	Brown	Red	Black
	Weight (kg)	0.07	0.09	0.12	0.15	0.2	0.3	0.38	0.51	0.6	0.66	0.94	1.23	2.07
	Product Code	GLFM12	GLFM14	GLFM16	GLFM18	GLFM20	GLFM22	GLFM25	GLFM28	GLFM30	GLFM32	GLFM36	GLFM40	GLFM50

Imperial Dimensions	Bar Diameter	#4	#5	#6	#7	#8	#9	#10	#11	#14	#18
	External Dia (inch)	1	1 1/8	1 3/8	1 5/8	1 6/8	2 2/8	2 2/8	2 3/8	3 1/8	4
	Splice Length (inch)	2 7/8	3 2/8	4	4 5/8	5 3/8	6 6/8	6 6/8	7 5/8	10 2/8	14 5/8
	Color Code	Orange	Pink	Dark Green	White	Blue	Levander	Yellow	Brown	Claret Red	Black
	Weight (lbs)	0.15	0.20	0.26	0.33	0.44	0.66	0.84	1.12	1.42	1.66
	Product Code	GLFMI#4	GLFMI#5	GLFMI#6	GLFMI#7	GLFMI#8	GLFMI#9	GLFMI#10	GLFMI#11	GLFMI#14	GLFMI#18

COATING OPTIONS

Epoxy coated mechanical couplers for splicing epoxy coated bars that comply with ASTM A775/A775M.

Hot dip galvanized mechanical couplers for splicing galvanized bars that comply with ASTM A767/A767M.

Stainless steel Griplock swaging couplers for splicing stainless steel bars and special use.

After tightening, there should be no more than 2-4 mm of thread exposed plus half the length of the coupler depending on the diameter of the rebar. Detailed visual control and quality assurance information are available upon request.

Contact BARUS for reusable accessories and waste-reducing products for LEED and environmentally friendly projects.



01

Remove the BARUS coupler caps from both female and male couplers.



02

Screw the male coupler into the female coupler until it hits the end of the coupler and lock tight.



griplock ps

GripLock PS is a position coupler with a threaded stud between two female GripLock couplers. It is used for applications where bars can not be rotated or it is not practical to rotate the bars due to bent bars, pile installations to engage the threads or when bars are too long and heavy.



griplock ps INSTALLATION

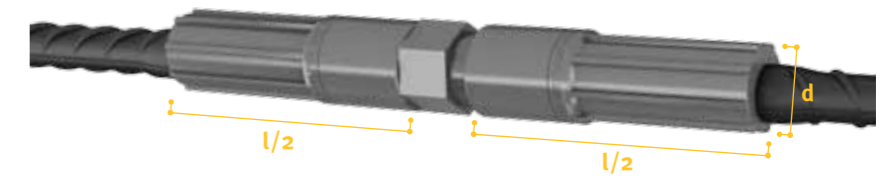

Metric Dimensions	Bar Diameter	12	14	16	18	20	22	25	28	30	32	36	40	50
	External Dia (mm)	24	26	29	31	35	40	44	49	56	56	60	70	79
	Splice Length (mm)	72	77	82	92	103	117	138	152	173	173	193	224	285
	Color Code	Orange	Purple	Pink	Grass Green	Dark Green	White	Blue	Levander	Grey	Yellow	Brown	Red	Black
	Weight (kg)	0.07	0.09	0.12	0.15	0.2	0.3	0.38	0.51	0.6	0.66	0.94	1.23	2.07
	Product Code	GLPS12	GLPS14	GLPS16	GLPS18	GLPS20	GLPS22	GLPS25	GLPS28	GLPS30	GLPS32	GLPS36	GLPS40	GLPS50

Imperial Dimensions	Bar Diameter	#4	#5	#6	#7	#8	#9	#10	#11	#14	#18
	External Dia (inch)	1	1 1/8	1 3/8	1 5/8	1 6/8	2 2/8	2 2/8	2 3/8	3 1/8	4
	Splice Length (inch)	2 7/8	3 2/8	4	4 5/8	5 3/8	6 6/8	6 6/8	7 5/8	10 2/8	14 5/8
	Color Code	Orange	Pink	Dark Green	White	Blue	Levander	Yellow	Brown	Claret Red	Black
	Weight (lbs)	0.15	0.20	0.26	0.33	0.44	0.66	0.84	1.12	1.42	1.66
	Product Code	GLPSI#4	GLPSI#5	GLPSI#6	GLPSI#7	GLPSI#8	GLPSI#9	GLPSI#10	GLPSI#11	GLPSI#14	GLPSI#18

COATING OPTIONS

Epoxy coated mechanical couplers for splicing epoxy coated bars that comply with ASTM A775/A775M.

Hot dip galvanized mechanical couplers for splicing galvanized bars that comply with ASTM A767/A767M.

Stainless steel Griplock swaging couplers for splicing stainless steel bars and special use.

After tightening, there should be no more than 2-4 mm of thread exposed plus half the length of the coupler depending on the diameter of the rebar. Detailed visual control and quality assurance information are available upon request.

Contact BARUS for reusable accessories and waste-reducing products for LEED and environmentally friendly projects.

01

Screw the stud fully into the long coupler until it stops.



02

Align and move the long coupler toward the short coupler until the threaded head of the stud prevent assembly. Do not turn the short coupler.



03

Screw the stud fully into the short coupler until it stops.

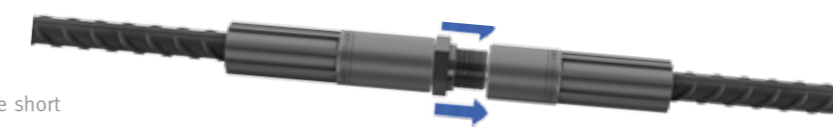

04

Use a pipe wrench to tighten stud to lock the connection. No specific torque amount is required.





griplock crossing

GripLock Crossing Coupler System comprises a long threaded stud between two female GripLock couplers. It is used when the bars cannot be placed butt to butt in challenging rebar cages or difficult installations.



griplock crossing INSTALLATION

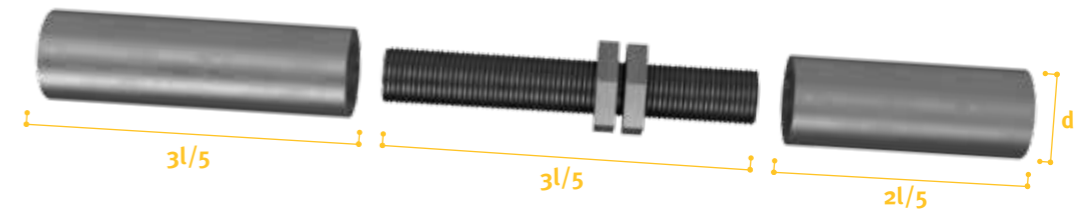

Bar Diameter	12	14	16	18	20	22	25	28	30	32	36	40	50
External Dia (mm)	24	26	29	31	35	40	44	49	56	56	60	70	79
Splice Length (mm)	77	82	92	103	117	138	152	173	173	193	224	269	295
Color Code	Orange	Purple	Pink	Grass Green	Dark Green	White	Blue	Levander	Grey	Yellow	Brown	Red	Black
Weight (kg)	0.09	0.12	0.15	0.2	0.3	0.39	0.52	0.6	0.66	0.88	1.2	2.1	2.27
Product Code	GLCS12	GLCS14	GLCS16	GLCS18	GLCS20	GLCS22	GLCS25	GLCS28	GLCS30	GLCS32	GLCS36	GLCS40	GLCS50

Bar Diameter	#4	#5	#6	#7	#8	#9	#10	#11	#14	#18
External Dia (inch)	1	1 1/8	1 3/8	1 5/8	1 6/8	2 2/8	2 2/8	2 3/8	3 1/8	4
Splice Length (inch)	3	3 5/8	4 5/8	5 3/8	6	6 6/8	7 5/8	8 7/8	12 2/8	15 1/8
Color Code	Orange	Pink	Dark Green	White	Blue	Levander	Yellow	Brown	Claret Red	Black
Weight (lbs)	0.20	0.26	0.33	0.44	0.66	0.86	1.15	1.32	1.56	2.21
Product Code	GLCS#4	GLCS#5	GLCS#6	GLCS#7	GLCS#8	GLCS#9	GLCS#10	GLCS#11	GLCS#14	GLCS#18

COATING OPTIONS

Epoxy coated mechanical couplers for splicing epoxy coated bars that comply with ASTM A775/A775M.

Hot dip galvanized mechanical couplers for splicing galvanized bars that comply with ASTM A767/A767M.

Stainless steel Griplock swaging couplers for splicing stainless steel bars and special use.

After tightening, there should be no more than 2-4 mm of thread exposed plus half the length of the coupler depending on the diameter of the rebar. Detailed visual control and quality assurance information are available upon request.

Contact BARUS for reusable accessories and waste-reducing products for LEED and environmentally friendly projects.

01

Screw the stud fully into the long coupler until it stops. Align and move the long coupler toward the short coupler until the threaded head of the stud goes inside the coupler fully and stops at the thread.

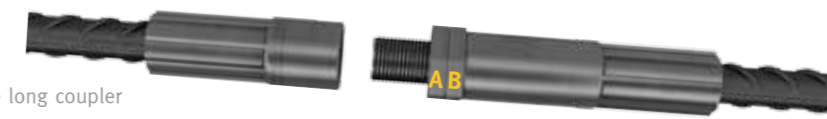

02

Turn nuts to screw the stud into the standard coupler. When the stud stops at nut A, tighten nut A and turn out B to lock its position.



03

Use a pipe wrench to tighten both nut A and nut B to lock the connection. No specific torque amount is required.



OTHER GRIPLOCK TYPES AND TYPICAL CONNECTIONS



griplock with anchor plate

Using Griplock System with an anchor plate provides anchorage in different applications.

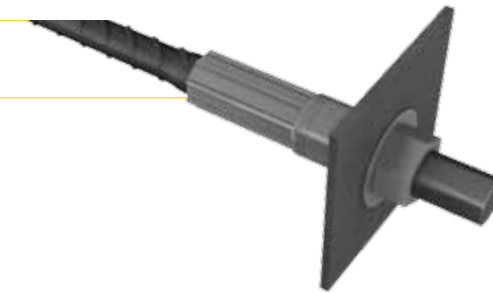

Metric Dimensions	Bar Diameter	12	14	16	18	20	22	25	28	30	32	36	40	50
	External Dia (mm)	24	26	29	31	35	40	44	49	56	56	60	70	79
	Splice Length (mm)	48	52.5	57	64	71.5	80.5	94	104	116.5	120	132.5	152	192.5
	Color Code	Orange	Purple	Pink	Grass Green	Dark Green	White	Blue	Levander	Grey	Yellow	Brown	Red	Black
	Weight (kg)	0.07	0.09	0.12	0.15	0.2	0.3	0.38	0.51	0.6	0.66	0.94	1.23	2.07
	Product Code	GLAN12	GLAN14	GLAN16	GLAN18	GLAN20	GLAN22	GLAN25	GLAN28	GLAN30	GLAN32	GLAN36	GLAN40	GLAN50

Imperial Dimensions	Bar Diameter	#4	#5	#6	#7	#8	#9	#10	#11	#14	#18
	External Dia (inch)	1	1 1/8	1 3/8	1 5/8	1 6/8	2 2/8	2 2/8	2 3/8	3 1/8	4
	Splice Length (inch)	1 7/8	2 2/8	2 7/8	3 1/8	3 6/8	4 5/8	4 6/8	5 2/8	6 7/8	9 7/8
	Color Code	Orange	Pink	Dark Green	White	Blue	Levander	Yellow	Brown	Claret Red	Black
	Weight (lbs)	0.15	0.20	0.26	0.33	0.44	0.66	0.84	1.12	1.42	1.66
	Product Code	GLANI#4	GLANI#5	GLANI#6	GLANI#7	GLANI#8	GLANI#9	GLANI#10	GLANI#11	GLANI#14	GLANI#18

griplock bolcon

Griplock bolcon couplers are used to unite rebars to a metal object through an 8.8 heavy duty bolt.

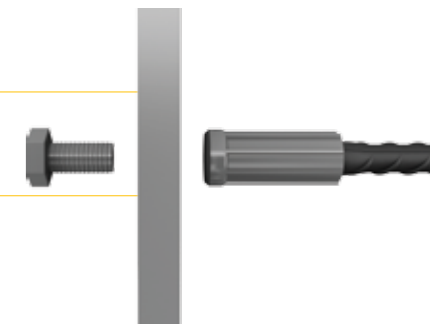

Metric Dimensions	Bar Diameter	12	14	16	18	20	22	25	28	30	32	36	40	50
	External Dia (mm)	24	26	29	31	35	40	44	49	56	56	60	70	79
	Splice Length (mm)	42	45.5	49	55	61.5	69.5	81.5	90	101.5	104	114.5	132	167.5
	Color Code	OrBCge	Purple	Pink	Grass Green	Dark Green	White	Blue	LevBCder	Grey	Yellow	Brown	Red	Black
	Weight (kg)	0.07	0.09	0.12	0.15	0.2	0.3	0.38	0.51	0.6	0.66	0.94	1.23	2.07
	Product Code	GLBC12	GLBC14	GLBC16	GLBC18	GLBC20	GLBC22	GLBC25	GLBC28	GLBC30	GLBC32	GLBC36	GLBC40	GLBC50

Imperial Dimensions	Bar Diameter	#4	#5	#6	#7	#8	#9	#10	#11	#14	#18
	External Dia (inch)	1	1 1/8	1 3/8	1 5/8	1 6/8	2 2/8	2 2/8	2 3/8	3 1/8	4
	Splice Length (inch)	1 5/8	1 7/8	2 3/8	2 6/8	3 2/8	4	4 1/8	4 4/8	6	8 5/8
	Color Code	Orange	Pink	Dark Green	White	Blue	Levander	Yellow	Brown	Claret Red	Black
	Weight (lbs)	0.15	0.20	0.26	0.33	0.44	0.66	0.84	1.12	1.42	1.66
	Product Code	GLBCI#4	GLBCI#5	GLBCI#6	GLBCI#7	GLBCI#8	GLBCI#9	GLBCI#10	GLBCI#11	GLBCI#14	GLBCI#18

GRIPLOCK SYSTEM WITH Anchor-Nut™



Griplock System Couplers can be used with Anchor Nut. In order to provide simple and fast anchorage, Griplock system is an efficient solution.

Connecting Different Diameters with GRIPLOCK TS Transition Couplers



When a tensile load is applied to a hooked bar embedded in concrete, a complex stress pattern is generated on the inside radius of the bent bar. Most likely, the bar tends to straighten and cause splitting of the concrete cover in the plane of the hook. At the same time, there is a high risk of concrete crushing beneath a bent anchorage. The primary objective of architects and engineers is to minimize structural element size. Building code requirements for hooked bars can compromise such objectives. Utilizing hooked bars will result in steel congestion, making the fabrication and construction more complicated. Geometric limitations often prevent the use of larger diameter reinforcing bars due to construction limitations arising from lengthy hook extensions and large bend diameters. If spalling of concrete cover occurs around the leg of a hook bar, by fire, corrosion or another mechanism, the effectiveness of the hook is severely compromised.

READY TO INSTALL MECHANICAL SPLICE PRODUCTS

BARUS produce any size of pre fabricated rebar-coupler-rebar head combinations. We produce odd lengths with no waste, resulting in a lower cost to our customers. Special types of BARUS Couplers and Anchor-Nut™s are designed, manufactured and installed on rebars as your requirements and ready to deliver at your job site. Please get in contact with us for your specific requirements.

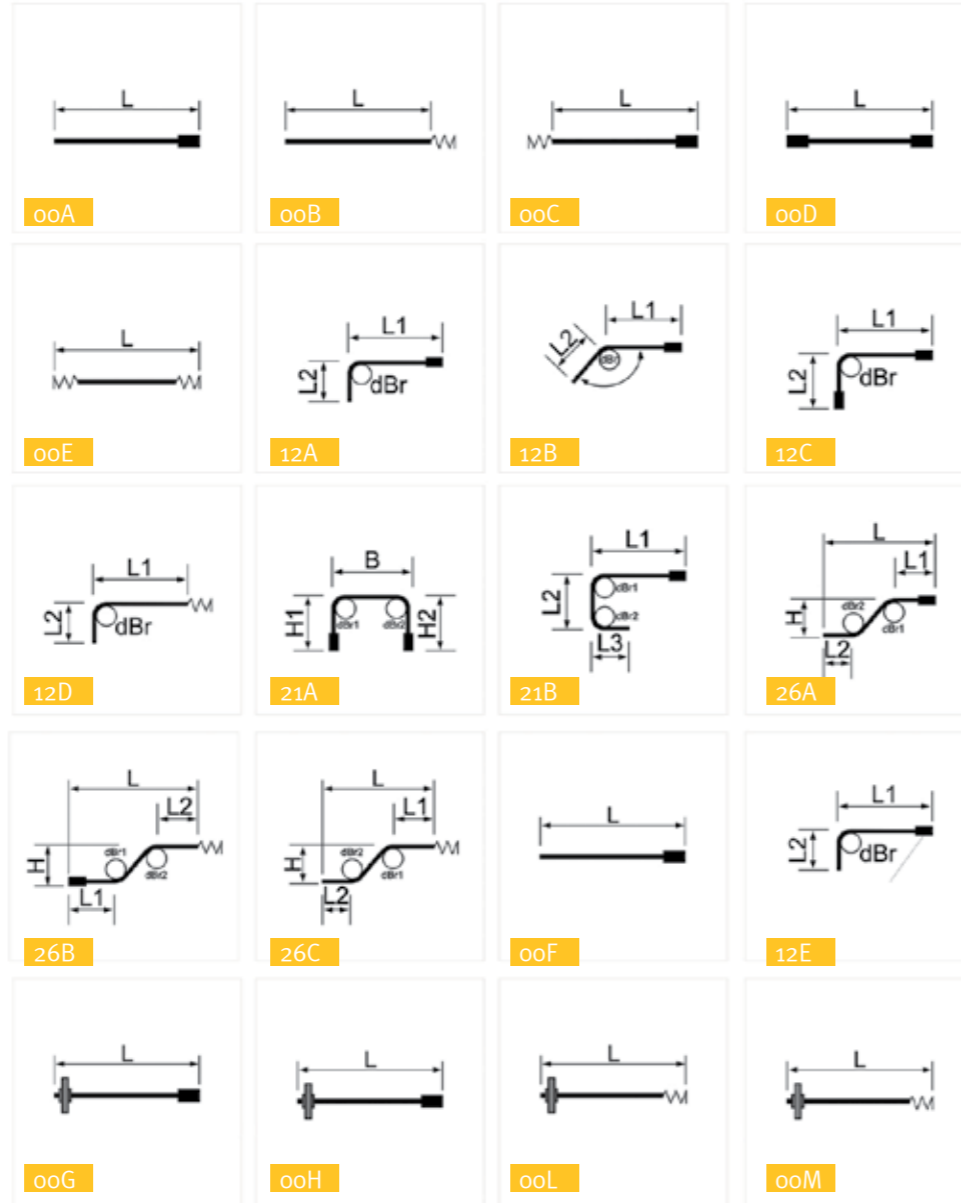

Special production types are cost efficient because we manufacture them in our plant and deliver it to your jobsite.

We can combine coupler, Anchor-Nut™, welding and threading according to your specific requirements.

Please contact us for your specific requirements.



ACCESSORIES



Concrete Spacer Plug

BARUS Concrete Spacer Plugs combine a traditional concrete reservation and a form adapter. Used primarily with the SimGrip™ LT and the SimGrip™ PS couplers, it creates a pocket in the concrete while its collar enables nailing to the formwork.



Form Adapter

BARUS Form Adapters are used to attach the coupler to formwork. When used with the threaded rebar, the formwork does not require rebar holes in order to have a continuous path of reinforcement.



Plastic Sleeve

BARUS marked plastic sleeve are used to protect the threaded rebar end. Like other plastic products, the plastic sleeve is color coded to indicate the size of the rebar.



Plastic Plug

BARUS marked plastic plug is used to protect the threads of the color. Like other plastic products, the plastic plug is color coded to indicate the size of the rebar.

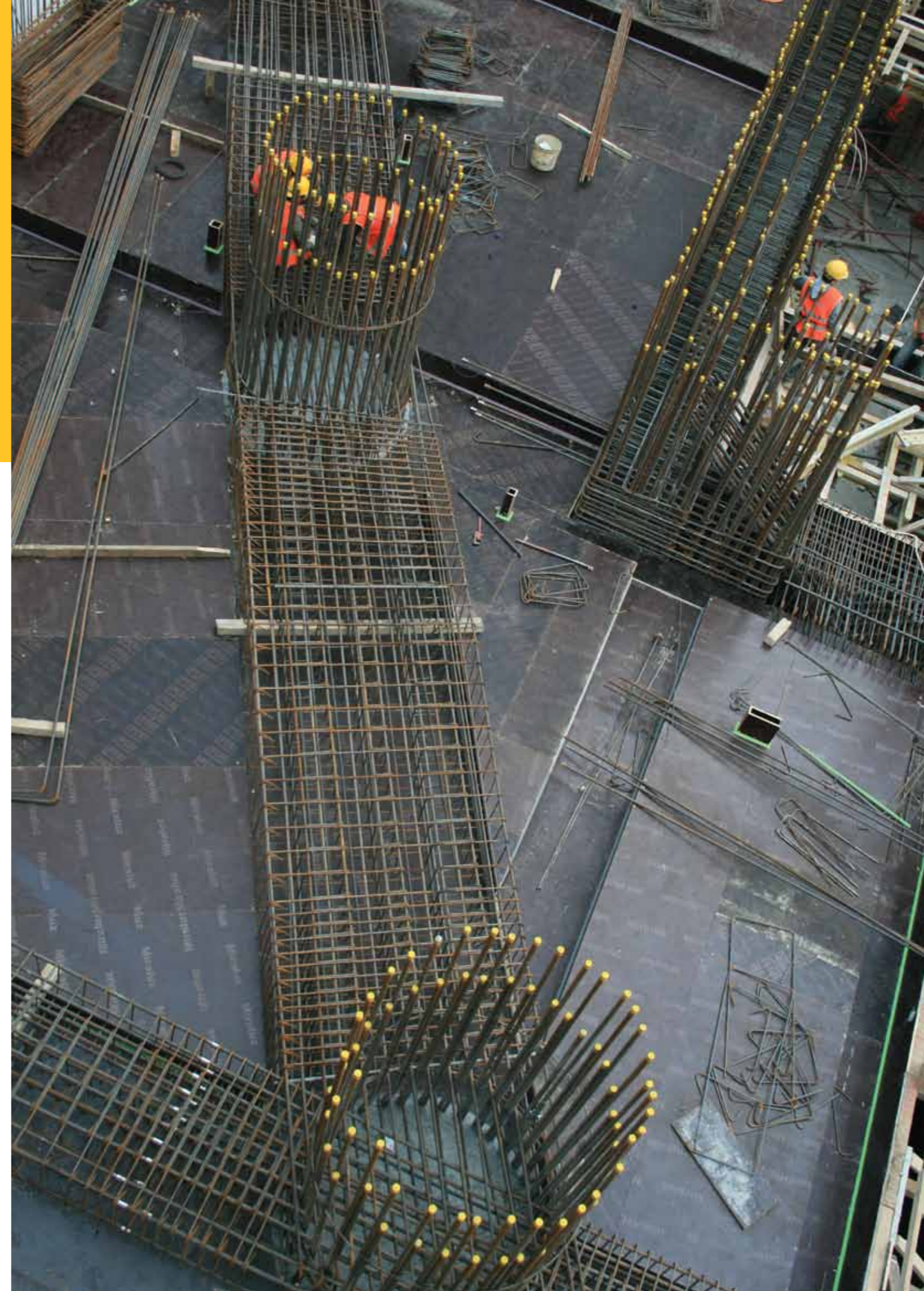



The information provided in this brochure and in our web site is of a promotional nature only. The construction applications and details provided in this literature are indicative only. In every case, project working details should be entrusted to appropriately qualified and experienced persons. Whilst every care has been exercised in the preparation of this document to ensure that any advice, recommendations or information is accurate, no liability or responsibility of any kind is accepted product design and specification without due notice.



www.bar-us.com

info@bar-us.com

This brochure is printed on paper produced from 80% recycled post-consumer fibre and 20% virgin pulp which is sourced from responsibly managed and sustainable forests (FSC certified). The printing inks and sealant are vegetable based making the document fully recyclable.



recycle

When you have finished with this literature please recycle it

80% recycled

This Literature is printed on 80% recycled paper